



*Multisystem inflammatory syndrome in children (MIS-C) is a rare inflammatory syndrome with multisystem involvement affecting children exposed to COVID-19. It emerged in Singapore as the incidence of COVID-19 in the community increased in 2021.*

*A Singapore observational study on cases fulfilling the Ministry of Health criteria for MIS-C from January 2020 to December 2021 was conducted in the country's biggest paediatrics hospital. All patients had mucocutaneous features similar to Kawasaki disease, frequently presenting with haematological, gastrointestinal and cardiovascular symptoms.*

*Multidisciplinary management, timely diagnosis, and early treatment with intravenous immunoglobulin and steroids likely contributed to good outcomes.*

Illustration by Xinyu Li

- 666 **Multisystem inflammatory syndrome in children: A unique manifestation of COVID-19**  
*Si Min Chan*
- 669 **Multisystem inflammatory syndrome in children in Singapore**  
*Karen Donceras Nadua, Chia Yin Chong, Kai-Qian Kam, Yee Hui Mok, Jonathan Tze Liang Choo, Joyce Ching Mei Lam, Jiahui Li, Natalie Woon Hui Tan, Chee Fu Yung, Su-Wan Bianca Chan, Kai Liang Teh, Lena Das, Thaschawee Arkachaisri, Koh Cheng Thoon*
- 677 **Improving drug allergy label accuracy by supervised safety and protocol-driven evaluation**  
*Chiara Jiamin Chong, Karen Jui Lin Choo, Kheng Yong Ong, Vivian Tan, Janet Beng Neo Khoo, Kavitha Garuna Murthee, Ibrahim Muhammad Hanif, Chaw Su Naing, Haur Yueh Lee*
- 686 **Non-alcoholic fatty liver disease screening in type 2 diabetes mellitus: A cost-effectiveness and price threshold analysis**  
*Bryan Peide Choo, George Boon-Bee Goh, Sing Yi Chia, Hong Choon Oh, Ngiap Chuan Tan, Jessica Yi Lyn Tan, Tiing Leong Ang, Yong Mong Bee, Yu Jun Wong*
- 695 **National surgical antibiotic prophylaxis guideline in Singapore**  
*Wei Teng Gladys Chung, Humaira Shafi, Jonathan Seah, Parthasarathy Purnima, Taweechai Patun, Kai-Qian Kam, Valerie Xue Fen Seah, Rina Yue Ling Ong, Li Lin, Robin Sing Meng Choo, Pushpalatha Lingegowd, Cheryl Li Ling Lim, Jasmine Shimin Chung, Nathalie Grace SY Chua, Tau Hong Lee, Min Yi Yap, Tat Ming Ng, Jyoti Somani*
- 712 **The Omicron-transformer: Rise of the subvariants in the age of vaccines**  
*Travis Ren Teen Chia, Barnaby Edward Young, Po Ying Chia*

# ANNALS

Official Journal of the Academy of Medicine, Singapore

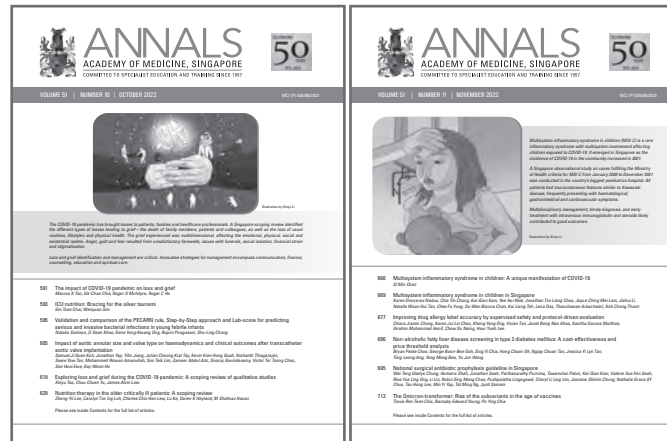

## Call for Papers

The *Annals* is the official medical journal of the Academy of Medicine, Singapore. Established in 1972, the monthly peer-reviewed journal seeks to publish novel findings from clinical research and medical practices that can benefit the medical community.

The *Annals* is indexed in Index Medicus, Science Citation Index Expanded, ISI Alerting Services, and Current Contents/Clinical Medicine. Impact Factor for the *Annals* in 2021 is 8.713 and 5-year Impact Factor is 5.544.

The *Annals* invites submission of manuscripts that advance the scientific basis of clinical knowledge, and the practice of medicine in Singapore and internationally. We welcome submissions that address challenges in the management of chronic diseases (e.g. cancer, cardiovascular diseases, ageing, diabetes mellitus and neurological diseases), and use of technology and digital medicine to improve patient care.

For guidance on manuscript preparation, instructions for authors are available at: <https://annals.edu.sg/instructions-for-authors>. The descriptions and guidelines for all categories of articles that are published in the journal are available at: [https://annals.edu.sg/wp-content/uploads/2021/06/Guidelines\\_for\\_Publication\\_categories.pdf](https://annals.edu.sg/wp-content/uploads/2021/06/Guidelines_for_Publication_categories.pdf).

For submission of manuscript, please visit the online manuscript submission system: <https://aams.manuscriptmanager.net>. For queries on submission, please direct these to: [annals@ams.edu.sg](mailto:annals@ams.edu.sg).

## Editor-in-Chief

Raymond [Seet](#)

## Deputy Editors

Deidre Anne [De Silva](#)

Beng Yeong [Ng](#)

## Board Members

Ling Ling [Chan](#)

Roger [Ho](#)

Ravindran [Kanesvaran](#)

Felix [Keng](#)

Mariko [Koh](#)

Alfred [Kow](#)

Jan Hau [Lee](#)

Tchoyoson [Lim](#)

Anselm [Mak](#)

Joseph [Ng](#)

Dujeepa [Samarasekera](#)

Mythily [Subramaniam](#)

Clement [Tan](#)

Tjun Yip [Tang](#)

## Associate Editors

Brian [Goh](#)

Li Yang [Hsu](#)

## Emeritus Editors

Vernon MS [Oh](#)

Eng King [Tan](#)

## Immediate Past Editor

Erle [Lim](#)

## Deputy Manager

Lay Leng [Tan](#)

## Editorial Executives

Nuraiziah [Johari](#)

Xinyu [Li](#)

## Call for papers on topical medical research

The rapidly ageing population and enlarging burden of chronic diseases require a proportionate emphasis on health promotion and disease prevention. A health system that is more data-driven and patient-centric, which leverages the innovative use of technology and digital solutions, will be an area warranting research attention and coverage.

The *Annals* invites submission of manuscripts that advance the scientific basis of clinical knowledge, and the practice of medicine in Singapore and internationally. We welcome submissions that address challenges in the management of chronic diseases (e.g. cancer, cardiovascular diseases, ageing, diabetes mellitus and neurological diseases), and use of technology and digital medicine to improve patient care. Submit your papers at: <https://aams.manuscriptmanager.net>.

## Send us your images and tweetable abstracts!



Follow us on Twitter: [@AnnalsSG](#)  
and Instagram: [@annals\\_singapore](#)

The *Annals* invites you to submit high-resolution **images of current and historical importance in medicine**, with a short caption of about 100 words. Due acknowledgement will be given to published images. Please send your photos to [annals@ams.edu.sg](mailto:annals@ams.edu.sg).

When submitting an Original Article and Review Article, we encourage authors to include a focused **tweetable abstract** in 140 characters or less. Share with us your Twitter handle if you are on Twitter too, so we can tag you.

More details for submission are available at:  
<https://annals.edu.sg/instructions-for-authors>

Printed by Straits Printers (Pte) Ltd

ISSN 0304-4602

MCI (P) 026/06/2022

## Multisystem inflammatory syndrome in children: A unique manifestation of COVID-19

Si Min Chan<sup>1</sup>*FRCPC (UK)*

During the coronavirus disease 2019 (COVID-19) pandemic, children have been relatively spared from the severe symptomatic infection affecting adults, particularly the elderly and those with comorbidities. One of the most challenging aspects of paediatric SARS-CoV-2 infection has been the discovery of a unique late manifestation of infection characterised by fever, systemic inflammation and multiorgan involvement. First described in April 2020, it was termed paediatric inflammatory multisystem syndrome temporally associated with SARS-CoV-2 (PIMS-TS) or multisystem inflammatory syndrome in children (MIS-C). Since then, confronting this new childhood inflammatory disorder has been fraught with challenges including variable case definitions, non-specific symptoms, treatment strategies extrapolated from other inflammatory conditions and adult experience, and unknown pathophysiology, risk factors and incidence of severe outcomes or long-term sequelae. Furthermore, although similarities between MIS-C and the well-described Kawasaki disease (KD) suggest that the 2 disorders lie on the same clinical and pathophysiological spectrum, MIS-C has emerged as a distinct entity affecting older children with more intense inflammation, increased shock and gastrointestinal manifestations, more thrombocytopenia and lymphopenia, and a greater propensity for myocardial rather than coronary artery injury.

Nadua et al.<sup>1</sup> describe 12 cases of MIS-C in late 2021 after the Delta wave in Singapore, presenting at median age of 7.5 years, at a median interval of 25 days after SARS-CoV-2 infection or exposure. Eleven cases had mild or asymptomatic COVID-19. All developed conjunctivitis and coagulopathy. Half had shock requiring intensive care, while 4 patients required inotropic support. Similar to other studies, gastrointestinal symptoms were commonly seen (75%), followed by neurological (42%), respiratory (33%) and renal (33%) involvement. Fever defervesced quickly at about

2 days and C-reactive protein normalised around 2 weeks, after treatment with intravenous immunoglobulin (IVIg), steroids and aspirin. A range of low- to high-dose steroids was used depending on symptom severity. One child with refractory symptoms improved quickly after receiving anakinra. Overall, there was a short median hospitalisation and intensive care stay of 6 and 3 days, respectively. All patients described survived, while other large studies reported low mortality  $\leq 2\%$ .<sup>2,3</sup>

This small case series provides insight into the key demographic Singapore population at risk for MIS-C. Large surveillance studies in Sweden<sup>2</sup> and the US<sup>4</sup> have identified young school-aged children to be at the highest risk. Other associated factors are males, foreign-born parents, asthma, obesity and chronic medical conditions. While KD is more common in Japan and East Asia, MIS-C is over-represented in non-Hispanic Black children, who also have a 1.7 odds ratio of decreased cardiac function.<sup>5</sup> Scarce incidence and outcome data are available for ethnic disparities in East Asia and could not be assessed here, but patients belonged to all 3 main ethnic groups in Singapore. The clinical spectrum seen in Singapore is consistent with previous literature.<sup>3</sup> Notably, shock was seen in 50% of MIS-C, significantly more than  $<10\%$  of KD. Abrams et al. described such patients as having a sepsis-like presentation with more abdominal pain, shortness of breath, and markedly deranged inflammatory and cardiac biomarkers.<sup>5</sup>

Nadua et al. reported that 83% of their patients had cardiovascular involvement; 8 of 11 children had abnormal echocardiogram findings during admission, and 8 of 10 had elevated N-terminal pro-B-type natriuretic peptide (NT-proBNP) levels. Cardiac involvement included coronary artery abnormalities (CAAs) in 3 patients from as early as day 4–5 of illness, ventricular dilatation in 3 patients, and reduced cardiac function in 4 patients. Seven of 8 patients with abnormal echocardiograms had complete resolution

<sup>1</sup> Division of Paediatric Infectious Diseases, Department of Paediatrics, Khoo Teck Puat–National University Children’s Medical Institute, National University Hospital, Singapore

Correspondence: Dr Si Min Chan, Division of Paediatric Infectious Diseases, Department of Paediatrics, Khoo Teck Puat–National University Children’s Medical Institute, National University Hospital, 1E Kent Ridge Road, NUHS Tower Block Level 12, Singapore 119228.

Email: [si\\_min\\_chan@nuhs.edu.sg](mailto:si_min_chan@nuhs.edu.sg)



by 6 months post-discharge; reduced cardiac function resolved more quickly than CAAs (median time 14 days versus 42 days, respectively). However, similar to KD, late cardiac sequelae can occur. The authors report 2 Chinese boys, 11 and 4 years old, who had both rash and conjunctivitis. The first had mildly elevated NT-proBNP and a normal echocardiogram on day 7 of illness, but subsequently developed mild coronary artery dilatation on day 50, which was still present on day 218. The other had markedly elevated NT-proBNP and mildly reduced left ventricular function on day 7 resolving by day 10, but later developed mild coronary artery dilatation on day 22 that resolved by day 52. Males and patients with conjunctivitis and mucocutaneous lesions are more likely to develop CAAs, which may reflect a clinical picture more similar to KD.<sup>5</sup> Elevated proBNP and interleukin-6 are similarly associated with higher risk of CAAs but this threshold is unclear as mildly elevated BNP also occurs in non-cardiac inflammatory conditions.

Significant cardiac sequelae such as heart failure, CAAs and arrhythmias causing long-term morbidity are a major concern for patients and physicians. These may not be immediately apparent, and may occur in children who were not critically ill. So far, limited knowledge suggests a good prognosis. Inflammatory manifestations tend to resolve within 1–4 weeks. Farooqi et al. reported that in 45 children with MIS-C, 1 had persistent mild biventricular dysfunction and 1 had mild mitral and tricuspid regurgitation at 4–9 months.<sup>6</sup> Davies et al. reported 6 of 68 children had ongoing aneurysms at 86–336 days post-admission.<sup>7</sup> Although American College of Rheumatology guidelines<sup>8</sup> recommend echocardiograms at 1–2 weeks, 4–6 weeks, and then 1 year later for those with cardiac involvement during acute MIS-C, and more often for those with ventricular dysfunction or CAAs, it is unclear whether those with no acute cardiac involvement should have a similar follow-up. Arrhythmias presenting only post-acute illness may warrant electrocardiogram surveillance. Despite the rapid resolution of ventricular dysfunction, the occurrence of myocardial fibrosis and scarring as seen in other types of myocarditis may only be detected on cardiac magnetic resonance (CMR) imaging 2–6 months later. However, in a prospective study of 11 children with symptomatic COVID-19 and 6 with MIS-C, of whom 2 MIS-C participants had mild to moderate left ventricle dysfunction and 2 had mild coronary dilation, no significant cardiac disease by CMR and serum cardiac biomarkers were found 1–3

months later.<sup>9</sup> Larger studies are needed to determine the incidence of long-term myocardial injury, and to guide recommendations on the use of CMR, especially in resource-limited settings.

Diagnosis of MIS-C hinges on the presence of acute SARS-CoV-2 infection in the 2–8 weeks prior to presentation. Changing SARS-CoV-2 testing practices, vaccination, and serologic interpretation make establishing the timing of infection more complicated as the pandemic progresses. In the endemic phase of the pandemic, how recurrent infection affects the risk of developing MIS-C is currently unknown. While COVID-19 is not uncommon, the relative rarity of MIS-C means that investigation of other causes for febrile illness should be thorough to avoid misclassification of conditions with overlapping symptoms like KD shock syndrome, haemophagocytic lymphohistiocytosis, dengue fever, or toxic shock syndrome. International guidelines<sup>8,10</sup> based on consensus processes outline treatment strategies using immunomodulation, adjunctive antibiotics and/or antivirals, and anti-thrombotic therapy that are broadly similar, with uncertainty over optimal dose and timing of steroid administration, thrombotic and/or bleeding risks, and the benefit of IVIg in myocarditis. Ongoing clinical trials such as the MISTIC and RECOVERY trials will hopefully shed further light. Milder phenotypes with fever, rash, systemic inflammation but less organ involvement may not fulfil current diagnostic criteria, and may be managed conservatively. However, the risk of cardiac sequelae in this setting is unknown and the benefit of empiric IVIg to prevent CAAs is uncertain.

Overall, it is reassuring that MIS-C has a low incidence and mostly favourable outcomes with early diagnosis, aggressive supportive care, and immunomodulation when needed. Reducing the risk of MIS-C could be seen as another reason to prioritise young school-aged children for vaccination. The similarities and differences with KD may contribute to a better understanding of the genetic predispositions and immune mechanisms of the hyperinflammatory host response, even as the pathogenesis of KD has remained elusive for over 50 years. There remain many unknowns; population-based studies in different countries and communities are needed to contribute to evolving our understanding of MIS-C, and to define the pathophysiology, risk factors, and therapeutics to prevent and treat severe outcomes of shock and cardiac sequelae in affected children.

## REFERENCES

1. Nadua KD, Chong CY, Kam KQ et al. Multisystem inflammatory syndrome in children in Singapore. *Ann Acad Med Singap* 2022;51:669-96.
  2. Rhedin S, Lundholm C, Horne A, et al. Risk factors for multisystem inflammatory syndrome in children – A population-based cohort study of over 2 million children. *Lancet Reg Health Eur* 2022; 19:100443.
  3. Jiang L, Tang K, Irfan O, et al. Epidemiology, Clinical Features, and Outcomes of Multisystem Inflammatory Syndrome in Children (MIS-C) and Adolescents—a Live Systematic Review and Meta-analysis. *Curr Pediatr Rep* 2022;10:19-30.
  4. Payne AB, Gilani Z, Godfred-Cato S, et al. Incidence of multisystem inflammatory syndrome in children among US persons infected with SARS-CoV-2. *JAMA Netw Open* 2021;4:e2116420.
  5. Abrams JY, Oster ME, Godfred-Cato SE, et al. Factors linked to severe outcomes in multisystem inflammatory syndrome in children (MIS-C) in the USA: a retrospective surveillance study. *Lancet Child Adolesc Health* 2021;5:323-31.
  6. Farooqi KM, Chan A, Weller RJ, et al. Longitudinal Outcomes for Multisystem Inflammatory Syndrome in Children. *Pediatrics* 2021;148:e2021051155.
  7. Davies P, du Pré P, Lillie J, et al. One-Year Outcomes of Critical Care Patients Post-COVID-19 Multisystem Inflammatory Syndrome in Children. *JAMA Pediatr* 2021;175:1281-3.
  8. Henderson LA, Canna SW, Friedman KG, et al. American College of Rheumatology Clinical Guidance for Multisystem Inflammatory Syndrome in Children Associated With SARS-CoV-2 and Hyperinflammation in Pediatric COVID-19: Version 3. *Arthritis Rheumatol* 2022;74:e1-20.
  9. Webster G, Patel AB, Carr MR, et al. Cardiovascular magnetic resonance imaging in children after recovery from symptomatic COVID-19 or MIS-C: a prospective study. *J Cardiovasc Magn Reson* 2021;023:86.
  10. Harwood R, Allin B, Jones CE, et al. A national consensus management pathway for paediatric inflammatory multisystem syndrome temporally associated with COVID-19 (PIMS-TS): results of a national Delphi process. *Lancet Child Adolesc Health* 2021;5:133-41.
-

## Multisystem inflammatory syndrome in children in Singapore

Karen Donceras Nadua<sup>1,6,7,8</sup>MD, Chia Yin Chong<sup>1,6,7,8</sup>MBBS, Kai-Qian Kam<sup>1,6,7,8</sup>MBBS, Yee Hui Mok<sup>2,6,7</sup>MBBS, Jonathan Tze Liang Choo<sup>3,6,7,8</sup>MBBS, Joyce Ching Mei Lam<sup>4,6,7,8</sup>MBBS, Jiahui Li<sup>1,6,7,8</sup>MBBS, Natalie Woon Hui Tan<sup>1,6,7,8</sup>MBBS, Chee Fu Yung<sup>1,6,7,8</sup>MBCMB, Su-Wan Bianca Chan<sup>5,6,7,8</sup>MD, Kai Liang Teh<sup>5,6,7,8</sup>MBBS, Lena Das<sup>5,6,7,8</sup>MD, Thaschawee Arkachaisri<sup>5,6,7,8</sup>MD, Koh Cheng Thoon<sup>1,6,7,8</sup>MBBS

### ABSTRACT

**Introduction:** Multisystem inflammatory syndrome in children (MIS-C) is a rare inflammatory syndrome with multisystem involvement affecting children exposed to COVID-19. This condition is rarely reported in East Asia and was not detected in Singapore until 2021. We present 12 cases of MIS-C diagnosed in KK Women's and Children's Hospital (KKH) from October 2021 to December 2021.

**Method:** We conducted an observational study on cases fulfilling the Singapore Ministry of Health criteria for MIS-C from January 2020 to December 2021 in KKH. Medical records were reviewed to obtain information on clinical presentation, disease course, treatment received and outcomes.

**Results:** In the 12 cases detected, the median age was 7.50 years (interquartile range 4.00–9.25); 8 were male. All patients had mucocutaneous symptoms similar to Kawasaki disease. Other commonly involved systems were: haematological (coagulopathy 100%, lymphopaenia 91.70% and thrombocytopenia 75.00%), gastrointestinal (75.00%) and cardiovascular (83.30%). Six patients (50.00%) had shock and were admitted to the intensive care unit. The majority of patients received treatment within 2 days of hospitalisation with intravenous immunoglobulin (IVIg) and steroids. All survived; the majority had normal echocardiograms and no long-term organ sequelae at 6 months post-discharge.

**Conclusion:** MIS-C emerged in Singapore as the incidence of COVID-19 in the community increased in 2021. The clinical presentation of our patients is similar to earlier reports, with some significant differences from Kawasaki disease. Multidisciplinary management, timely diagnosis, and early initiation of treatment with IVIg and steroids likely contributed to comparatively good outcomes. Our cases highlight the need for continued awareness of MIS-C among physicians, and surveillance of its incidence, short- and long-term outcomes.

Ann Acad Med Singap 2022;51:669-76

**Keywords:** COVID-19, children, MIS-C, inflammation, paediatrics

### INTRODUCTION

While children infected with severe acute respiratory syndrome coronavirus 2 (SARS-CoV-2) resulting in coronavirus disease 2019 (COVID-19) have milder manifestations compared to adults,<sup>1,2</sup> a rare multisystem inflammatory syndrome leading to multiorgan failure

and shock (multisystem inflammatory syndrome in children [MIS-C]) has been recognised to affect children with exposure to COVID-19. MIS-C shares similar features with Kawasaki disease (KD), another inflammatory syndrome with mucocutaneous signs such as conjunctivitis and rash, and cardiac complications.<sup>3</sup>

<sup>1</sup> Infectious Disease Service, Department of Paediatrics, KK Women's and Children's Hospital, Singapore

<sup>2</sup> Children's Intensive Care Unit, Department of Paediatric Subspecialties, KK Women's and Children's Hospital, Singapore

<sup>3</sup> Cardiology Service, Department of Paediatric Subspecialties, KK Women's and Children's Hospital, Singapore

<sup>4</sup> Children's Blood and Cancer Centre, Department of Paediatric Subspecialties, KK Women's and Children's Hospital, Singapore

<sup>5</sup> Rheumatology and Immunology Service, Department of Paediatric Subspecialties, KK Women's and Children's Hospital, Singapore

<sup>6</sup> Duke-NUS Medical School, Singapore

<sup>7</sup> Yong Loo Lin School of Medicine, National University of Singapore, Singapore

<sup>8</sup> Lee Kong Chian School of Medicine, Nanyang Technological University, Singapore

Correspondence: Dr Karen Donceras Nadua, Department of Paediatrics, Level 3, Children's Tower, KK Women's and Children's Hospital, 100 Bukit Timah Road, Singapore 229899.

Email: [Karen.donceras.nadua@singhealth.com.sg](mailto:Karen.donceras.nadua@singhealth.com.sg)

## CLINICAL IMPACT

### What is New

- An increased number of cases of multisystem inflammatory syndrome in children (MIS-C) was observed during the Delta wave of COVID-19 in Singapore.
- In our series, patients had mucocutaneous features similar to Kawasaki disease, but also frequently presented with gastrointestinal symptoms, cardiovascular involvement, shock, coagulopathy, lymphopaenia and thrombocytopenia. Other systems' involvement was less common.

### Clinical Implications

- As COVID-19 becomes endemic in Singapore, young children could be more predisposed to MIS-C, especially unvaccinated individuals. Early diagnosis, treatment with intravenous immunoglobulin and steroids, and multidisciplinary management may result in good outcomes.

Initial reports of MIS-C largely came from the US and Europe.<sup>4-6</sup> In contrast, despite the high incidence of COVID-19 in East Asia, which includes China, Japan and Korea, reports of MIS-C are rare in this region.<sup>7-10</sup> For the first 20 months of the pandemic from January 2020 to September 2021, no cases of MIS-C were detected in Singapore.<sup>11</sup> In the year 2021, there was a sharp increase of COVID-19 infections due to the arrival of the highly transmissible Delta variant of concern (VOC),<sup>12</sup> and the transition of the national health policy to treat COVID-19 as an endemic disease. While Delta VOC has been shown to cause more severe presentation in adults,<sup>12</sup> whether it has altered the clinical pathology in children remains unknown. From October 2021 to December 2021, our hospital detected 12 cases of MIS-C. In this article, we describe their clinical presentation, disease course, treatment received and outcomes.

## METHOD

This was a retrospective observational study on MIS-C cases diagnosed in KK Women's and Children's Hospital (KKH) from January 2020 to 31 December 2021. KKH is a public paediatric tertiary hospital and the national centre for management of children with COVID-19 in Singapore.

Cases were defined according to the Singapore Ministry of Health (MOH) criteria for MIS-C (Table 1), which was adopted from the World Health Organization criteria.<sup>13</sup> Clinical information such as demographics, presenting symptoms, examination findings, laboratory results, treatment received, clinical course and outcomes were obtained through a review of medical records up to 6 months post-discharge. Data were analysed using descriptive statistics (median and interquartile range [IQR]) with Microsoft Excel). This study was approved by the institutional review board (CIRB No. 2020/2094). Written informed consent was waived in light of the need to inform public health outbreak control policies.

Table 1. Singapore Ministry of Health (MOH) case definition of multisystem inflammatory syndrome in children (MIS-C) (from MOH Circular 171/2021, 11 November 2021, reproduced with permission from MOH, Singapore).

### Criteria for case definition of MIS-C (all 6 criteria must be met)

1. Age 0–19 years
2. Persistent high fever (>38.5°C) for ≥3 days
3. Signs of multisystem involvement (at least 2 systems below):
  - a. Cardiovascular (e.g. raised cardiac biomarkers, pericarditis, coronary abnormalities and ECG abnormalities)
  - b. Hypotension or shock
  - c. Gastrointestinal (e.g. diarrhoea, vomiting and abdominal pain)
  - d. Mucocutaneous features (e.g. rash, conjunctivitis, mucositis, and swollen hands or feet)
  - e. Neurological manifestations (e.g. headache, altered mental state and seizures)
  - f. Haematological (e.g. lymphopaenia, thrombocytopenia and coagulopathy)
  - g. Respiratory (e.g. shortness of breath and tachypnoea)
  - h. Renal (e.g. markers of acute renal injury)
4. Elevated markers of inflammation (e.g. C-reactive protein, ferritin, procalcitonin and fibrinogen)
5. Other bacterial/viral causes are excluded
6. Evidence of current or recent COVID-19 infection (e.g. PCR-positive, serology-positive or -)

ECG: electrocardiogram; PCR: polymerase chain reaction

## RESULTS

We identified 12 cases of MIS-C. The summary of findings of their clinical characteristics, disease course, treatment received and outcomes are presented in online Supplementary Materials, Supplementary Table S1, while the details of each case are in online Supplementary Table S2. The majority of the patients were male (n=8, 66.67%). The median age was 7.50 years (IQR 4.00–9.25). Five patients were of Malay ethnicity, 4 were Chinese and 3 were Indians. Four patients (33.30%) had underlying chronic conditions—one with a history of cholesteatoma and recurrent middle



ear infections, one with epilepsy, one with recurrent wheezing and one with well-controlled asthma.

All patients had evidence of prior COVID-19 infection with a positive anti-N SARS-CoV-2 immunoglobulin G antibody (online Supplementary Table S1). Ten patients had history of confirmed COVID-19 infection with positive antigen rapid test or SARS-CoV-2 polymerase chain reaction (PCR). Two cases were close household contacts, but did not test positive during the acute infection—one had acute respiratory symptoms while the other was asymptomatic. Majority (n=11, 91.67%) had mild or asymptomatic infection. Two cases were hospitalised—one due to young age and one due to mild asthma exacerbation. The median interval between COVID-19 infection or exposure and the onset of MIS-C was 25.00 days (IQR 22.00–29.50).

All patients had involvement of at least 3 systems (online Supplementary Tables S1 and S2). Mucocutaneous features of conjunctivitis and haematological abnormality with coagulopathy (raised D-dimer or prolonged clotting time) were present in all patients. Lymphopaenia was found in 11 cases (91.7%) with a median absolute lymphocyte count of  $0.63 \times 10^9$  cells/L (IQR 0.49–0.83). Thrombocytopenia was present in 9 cases (75.00%), with a median platelet of  $101.50 \times 10^9$  cells/L (IQR 90.50–143.25).

Cardiovascular involvement was the next most common (n=10, 83.30%) with abnormalities in echocardiogram or raised N-terminal pro-B-type natriuretic peptide (NT-proBNP) levels. The following abnormalities were seen in 8 out of 11 patients (72.70%) with inpatient echocardiograms: coronary artery abnormalities (n=3), dilated ventricles (n=3) and reduced cardiac function (n=4) (online Supplementary Tables S1 and S2). NT-proBNP level  $>500\text{pg/mL}$  was seen in 8 out of 10 patients (median  $2558.50\text{pg/mL}$ , IQR 1118.25–10779.50). Six patients (50%) had shock and were admitted to the intensive care unit (ICU). All received fluid boluses and 4 required inotropic support. Case #2 had the most severe presentation, requiring triple inotropic support for 5 days.

Gastrointestinal symptoms comprising abdominal pain, vomiting and/or diarrhoea were present in 9 patients (75.00%). None were suspected of having appendicitis. Case #2 was referred to the surgeons as his abdominal ultrasound showed small bowel thickening and suspicion of intramural air. He was treated for enterocolitis, with bowel rest and antibiotics. Case #4 was diagnosed with mild pancreatitis, with mildly elevated amylase (maximum 216 U/L, normal 28–112 U/L). Among 5 patients who had abdominal ultrasonography, 3 had gallbladder wall thickening and 1 had hydrops.

Other systems' involvement was seen less frequently. Neurological involvement was seen in 5 patients (41.70%): 3 patients had headache, 1 patient with a background of epilepsy had breakthrough seizures occurring immediately prior to onset of fever, and 1 patient had aseptic meningitis. Four patients (33.30%) had respiratory involvement, with 1 patient (case #2), requiring mechanical ventilation. His chest radiograph showed bilateral pleural effusions and consolidation, and no infection was detected to cause such presentation. Four patients (33.30%) had acute kidney injury with mild elevation of creatinine.

All patients had elevated C-reactive protein (CRP) and procalcitonin, with a median of  $136.00\text{mg/L}$  (IQR 94.25–185.70) and  $2.74\mu\text{g/L}$  (IQR 0.88–19.14), respectively. Ferritin and lactate dehydrogenase were significantly elevated in some patients (online Supplementary Tables S1 and S2).

All patients received intravenous (IV) antibiotics and were worked up for infectious causes. Case #5's blood culture grew *Staphylococcus aureus*—while this was deemed likely a contaminant, IV antibiotics were continued for 1 week as he was on high-dose steroids. One patient was positive for rhinovirus/enterovirus; 2 patients were positive for SARS-CoV-2 but were likely shedding their previous COVID-19 infection. Tests for Group A *Streptococcus* infection with anti-streptolysin O titer, typhoid and dengue fever were also done with no significant positive results.

Both diagnosis of MIS-C and administration of treatment were done within a median of 2.00 days from admission (IQR 2.00–3.00) (online Supplementary Table S1). All patients received one dose of  $2\text{g/kg}$  of intravenous immunoglobulin (IVIg). Eleven patients (91.70%) received steroids in the form of IV methylprednisolone with subsequent conversion to oral prednisolone (online Supplementary Tables S1 and S2). Case #3 was not given steroids as the initial diagnosis was KD, and there was rapid improvement of fever and symptoms with IVIg alone. The initial dose of methylprednisolone varied from around  $1.25\text{mg/kg/day}$  (low dose) to  $30\text{mg/kg/day}$  (high dose). High-dose steroids were given for 3–5 days to all patients with shock, except for Case #6 as her haemodynamic status had rapidly stabilised after receiving low-dose steroids. Case #11 also received high-dose steroids due to persistently severe periorbital erythema and swelling despite low-dose steroids. Case #2 received subcutaneous anakinra, an interleukin-1 inhibitor, as he was still hypotensive and febrile with rising CRP despite IVIg and high-dose steroids. All patients received aspirin as an antiplatelet medication. Two

patients received clopidogrel instead of aspirin when their liver transaminases were elevated. Six patients (50%) received enoxaparin as antithrombotic prophylaxis (online Supplementary Tables S1 and S2).

Once treatment was initiated, there was rapid response in terms of fever, with a median time of 2.00 days (IQR 2.00–2.00) to defervescence (temperature  $<38^{\circ}\text{C}$  for at least 24 hours). For patients admitted to ICU, their median stay was 3.00 days (IQR 3.00–3.00). In the case of Case #2, he weaned off inotropes and extubated after 3 days since the addition of anakinra.

All patients survived and were discharged after a median hospital stay of 6.00 days (IQR 5.00–7.50). They were followed up by various subspecialties and are at least 6 months post-discharge at the time of writing. Case #11 was lost to follow-up after 16 days post-discharge. None were readmitted for recurrence of MIS-C. The median time to documented normalisation of CRP was 16.50 days (IQR 14.00–18.00) from onset of MIS-C and 12.50 days (IQR 10.75–14.25) from admission. Oral steroid was weaned once CRP normalised. The median total duration of steroids (including IV) was 42.00 days (IQR 26.00–49.50). Antiplatelet was continued for at least 6–8 weeks, or until echocardiograms were normal, whichever was later. The median duration of antiplatelet treatment is 52.50 days (IQR 48.50–60.00) as of writing, with case #5 still on aspirin as of 8 months post-discharge for his coronary artery dilation. Antithrombotic prophylaxis with enoxaparin was continued until D-dimer levels normalised or at  $<5$  times the upper normal limit. The median duration of enoxaparin was 17 days (IQR 8.50–20.25). Case #8, who had elevated D-dimer levels as his prothrombotic risk factor and was on enoxaparin, was readmitted 1 day after discharge for haematochezia. His anti-factor Xa level was within prophylactic range and he had no other risk factors for bleeding. Enoxaparin was stopped as his D-dimers had normalised.

Outpatient echocardiograms were performed for all patients between day 16 and day 286 post-MIS-C onset. Eleven patients had inpatient echocardiograms available for comparison—8 were abnormal with 7 subsequently having a normal outpatient scan, while the other 3 had normal findings during acute illness and on follow-up. Case #3 only had an outpatient echocardiogram, which was found to be normal. Among the 8 patients with inpatient abnormal scans, all but 1 (case #5) had a subsequent normal scan by 6 months post-discharge, with a median time of 16.50 days (IQR 14.00–44.50) for the resolution of any echocardiogram

abnormality from MIS-C onset (online Supplementary Tables S1 and S2). Median time to resolution from MIS-C onset for the 4 cases with reduced cardiac function and 3 cases with coronary artery abnormalities detected inpatient was 14 days (IQR 13.00–14.75) and 42 days (IQR 28–72), respectively. In 2 patients (cases #5 and #8), new coronary arterial dilation was detected in outpatient scans (on day 50 and day 22 of illness, respectively). This finding resolved by day 52 for case #8 while it was still detected in case #5 on day 218 (online Supplementary Table S2).

For other systems, by the last outpatient review at 16–286 days post-onset of MIS-C, most patients reported no significant residual abnormalities during their outpatient visits. One patient was readmitted 4 months later for chronic fatigue, body aches and low mood, and was diagnosed to have adjustment disorder on a background of social issues.

## DISCUSSION

Since 2020, KKH implemented a surrogate surveillance of MIS-C through the monitoring of KD incidence during the pandemic. We found no increase in KD incidence and admissions to the ICU due to KD in 2020 compared to the years before the COVID-19 pandemic.<sup>14,15</sup> The earlier absence of MIS-C in Singapore was possibly due to the lower COVID-19 incidence in children in 2020, with much fewer children infected compared to the rest of the population.<sup>16</sup> For the whole of 2020, only 265 children (aged 0–18 years) were infected (unpublished data from MOH, cited with permission from MOH, Singapore). In stark contrast to the earlier absence of MIS-C, the 12 cases in this report were diagnosed in a span of 9 weeks after October 2021, following the peak of the Delta wave, which saw more than 20,000 children (aged 0–18 years) infected with COVID-19 from September to December 2021 alone (unpublished data from MOH, cited with permission from MOH, Singapore). Leow et al. published one case of MIS-C diagnosed in the National University Hospital, Singapore in 2021.<sup>11</sup> On 6 November 2021, MIS-C was reported to have occurred in 4 out of the over 8,000 paediatric COVID-19 patients in Singapore since the start of the pandemic;<sup>17</sup> in the US, the reported incidence was 31.6 per 100,000 COVID-19 cases for persons  $<21$  years.<sup>18</sup> As the incidence of MIS-C reflects the level of COVID-19 transmission in the community, the arrival of the highly transmissible Omicron variant<sup>19</sup> in Singapore, and the move towards treating COVID-19 as an endemic virus may lead to a rise in MIS-C incidence.

In terms of clinical presentation, our results highlight the similarities and differences between MIS-C and KD described in prior reviews. The median age of our patients at 7.5 years is on the lower end of the reported range (7.3–10.8 years old) for MIS-C,<sup>20,23</sup> but older compared to the reported range for KD, which predominantly affects children aged <5 years.<sup>3</sup> The male predominance (66.67%) noted in our series has also been previously reported.<sup>20,22,23</sup> Race may be a risk factor as high incidence of MIS-C has been observed to occur in children of African, Hispanic or South Asian origin.<sup>20,22,23</sup> Racial proportion of COVID-19 infection rates alone could not account for the racial disparities observed in MIS-C incidence, suggesting a role for biological as well as social determinants in increasing inflammation and risk of more severe outcomes.<sup>24</sup> Our patients belonged to the 3 most common races in Singapore.<sup>25</sup> However, our sample size is not large enough to draw conclusions on any racial predisposition.

Common clinical features of MIS-C seen in our patients were mucocutaneous signs similar to KD, gastrointestinal involvement and shock. The latter 2 are known to be less frequent in KD.<sup>20,23</sup> Coagulopathy also has been frequently reported in MIS-C,<sup>26</sup> and thrombocytopenia and lymphopenia are more common in MIS-C<sup>22,23</sup> compared to KD.<sup>3</sup> Involvement of other systems such as neurological or respiratory system is less frequently reported in MIS-C.<sup>20,23</sup> Our case series also confirms the high morbidity of MIS-C with a high proportion requiring ICU care,<sup>22,23,27,28</sup> although mortality is low ( $\leq 2\%$ ).<sup>22,23,28,29</sup>

Our findings support the continued concern for MIS-C highlighted by MOH in its Circular No. 171/2021 to doctors (cited with permission from MOH, Singapore), with advice to suspect MIS-C in children with possible KD and consistent features of MIS-C, both within 2–8 weeks of confirmed COVID-19 infection. All our cases provided a history of diagnosed COVID-19 infection, and MIS-C occurred within a median of 25 days from the infection. However, as COVID-19 becomes endemic in Singapore, prior COVID-19 infection may not be readily apparent from history alone, which makes performing serology important to uncover previously undiagnosed COVID-19 infection.

The management of MIS-C in our institution involves multidisciplinary care according to guidelines jointly formulated by the paediatric intensive care units of KKH and National University Hospital, Singapore (Fig. 1). Prompt treatment of MIS-C with both IVIg

and steroids are our first-line therapy, with high-dose steroids given to those with shock or end-organ disease. This is in contrast to KD where steroids are used only in recalcitrant cases.<sup>3</sup> As such, the proportion of our steroid use (91.7%) is higher compared to previous reviews (range 49–63%).<sup>20,23,27</sup> The American College of Rheumatology (ACR) recommends a stepwise approach in the immunomodulatory treatment of MIS-C, with IVIg and low-to-moderate-dose of steroids to be used in hospitalised patients.<sup>30</sup> Observational studies have shown that initial treatment with IVIg plus steroids was associated with a more favourable fever course and less risk of cardiac dysfunction compared to IVIg alone,<sup>31,32</sup> while timely administration of anti-inflammatories may prevent progression and need for admission to ICU.<sup>33</sup> The use of anakinra is recommended by ACR in cases with refractory MIS-C despite IVIg and steroids.<sup>30</sup> Such cases are less common<sup>21,23,27</sup> with only 1 case in our series requiring this. Variations in treatment highlight the ongoing uncertainty about the ideal treatment strategy for MIS-C given the spectrum of severity. Randomised clinical trials are currently underway.<sup>34</sup>

Antiplatelet and antithrombotic prophylaxis are also part of our management as MIS-C causes a prothrombotic state.<sup>35</sup> For the management of antiplatelet prophylaxis, aspirin is recommended by ACR to be given to hospitalised MIS-C patients<sup>30</sup> and prior reviews report its common use.<sup>21,23</sup> For the management of antithrombotic prophylaxis, patients were first assessed for prothrombotic risk factors, such as age >12 years, immobility, high body mass index, mechanical ventilation, and D-dimer levels  $\geq 5$  times the upper limit of normal, prior to initiation of enoxaparin.<sup>36</sup> While bleeding due to antithrombotic prophylaxis in MIS-C is not common,<sup>35,37</sup> this was seen in one of our patients and is an adverse outcome that needs to be monitored.

With the current management strategy, the outcomes in our series have been favourable with a lower ICU admission rate (50% versus reported range of 60–79%)<sup>22,23,28</sup> and a comparable hospitalisation duration (median 6 days vs reported range 7–11 days),<sup>22,27,29</sup> compared to those reported. Our patients also had good cardiac outcomes, with all cases of reduced cardiac function subsequently normalised. Long-term cardiac sequelae seen in echocardiograms were also uncommon, as observed in only 1 patient, in keeping with previous reports.<sup>27,29</sup> Early diagnosis and administration of treatment likely contributed to the positive outcomes of our patients.



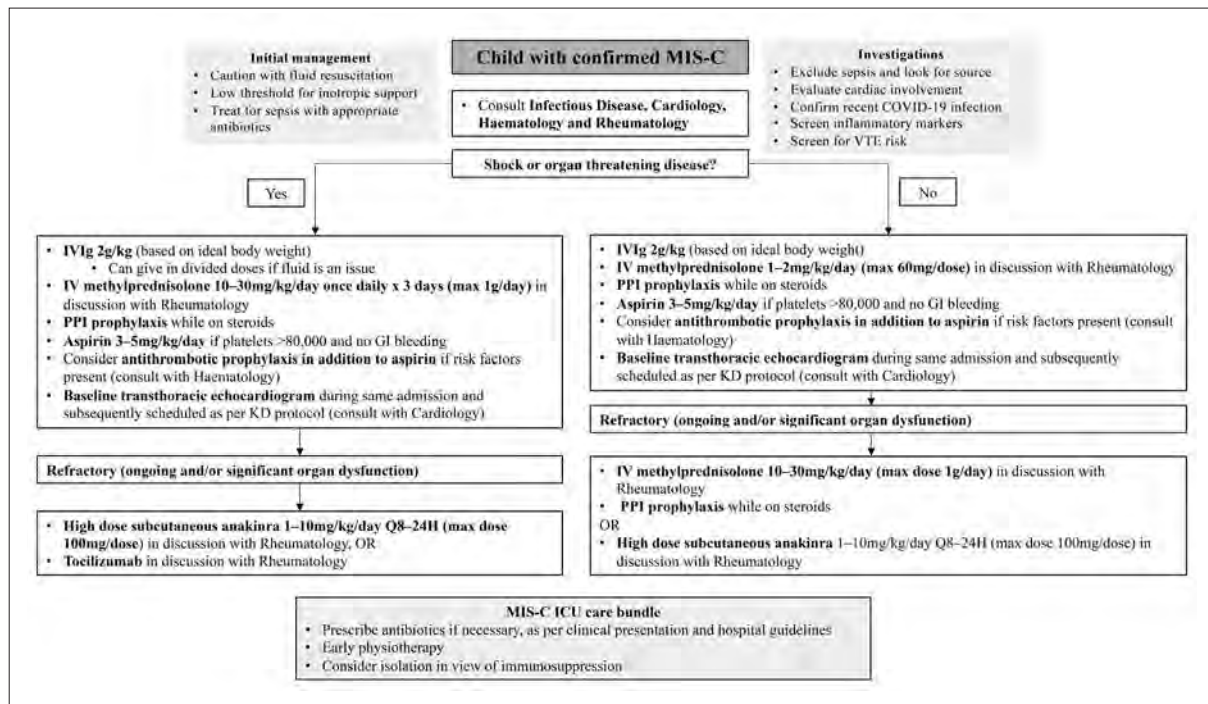

Fig. 1. Paediatric intensive care unit guidelines for multisystem inflammatory syndrome in children (MIS-C) of KK Women's and Children's Hospital (KKH) and National University Hospital (NUH), Singapore (published with permission from KKH and NUH), GI: gastrointestinal; ICU: intensive care unit; IVIg: intravenous immunoglobulin; KD: Kawasaki disease; PPI: proton pump inhibitor; VTE: venous thromboembolic

More commonly reported long-term sequelae of MIS-C are symptoms of muscular fatigue, neurological sequelae, anxiety and emotional lability.<sup>27</sup> While this was seen in one of our patients, there may be underdiagnosis as we relied on self-reporting for such symptoms.

An important strategy to mitigate the risk of MIS-C is vaccination against COVID-19, which has been shown to be associated with a lower incidence of MIS-C in adolescents.<sup>38</sup> In the US, as of 31 October 2022, 46.2% and 25.2% out of 9,073 MIS-C cases reported to the Centers for Disease Control and Prevention occurred in children 5–11 years old and <1–4 years old, respectively,<sup>39</sup> underlining the importance of vaccinating these age groups as well. At the time of their infection, none of our patients were age-eligible for vaccination—11 would have been eligible based on current MOH recommendations, with the recent inclusion for children aged 6 months to 4 years.<sup>40</sup> Unvaccinated children remain at a higher risk for COVID-19 and consequent risk for MIS-C.

Our study is limited in that it is a retrospective, single-centre study with a small sample size. Nonetheless, KKH is the largest tertiary paediatric hospital in Singapore and would have likely received the majority of MIS-C cases. Timings for evaluation of

inflammatory markers and echocardiograms were not standardised, and it is possible that values and scans normalised earlier than detected. We also did not actively survey for other system outcomes, such as neurological and respiratory symptoms. Despite these limitations, to our knowledge, our study is the first series on MIS-C in Singapore and East Asia, with outcome data up to 6 months post-discharge.

## CONCLUSION

Our study shows that children in Singapore are vulnerable to developing MIS-C especially during widespread community transmission of COVID-19, which may intensify with the arrival of new VOCs and relaxation of pandemic restrictions. Physicians should suspect MIS-C in febrile children with features of KD, and in children with recent COVID-19 infection together with gastrointestinal symptoms, shock, and haematologic abnormalities of coagulopathy, lymphopaenia and thrombocytopenia to diagnose MIS-C early and initiate prompt treatment with IVIg and steroids. The impact of the current Omicron surge on MIS-C incidence, and short- and long-term outcomes including side effects of treatment and non-cardiac sequelae, warrants continued surveillance and future studies.

### Acknowledgements

We would like to thank the Ministry of Health, Singapore for the assistance in providing national COVID-19 data used in this study, and all the healthcare workers and teams for the immense effort in caring for the children and their families during this ongoing COVID-19 pandemic.

### REFERENCES

- Castagnoli R, Votto M, Licari A, et al. Severe Acute Respiratory Syndrome Coronavirus 2 (SARS-CoV-2) Infection in Children and Adolescents: A Systematic Review. *JAMA Pediatr* 2020;174:882-9.
- Li J, Thoon KC, Chong CY, et al. Comparative Analysis of Symptomatic and Asymptomatic SARS-CoV-2 Infection in Children. *Ann Acad Med Singap* 2020;49:530-7.
- McCordle BW, Rowley AH, Newburger JW, et al. American Heart Association Rheumatic Fever, Endocarditis, and Kawasaki Disease Committee of the Council on Cardiovascular Disease in the Young; Council on Cardiovascular and Stroke Nursing; Council on Cardiovascular Surgery and Anesthesia; and Council on Epidemiology and Prevention. Diagnosis, Treatment, and Long-Term Management of Kawasaki Disease: A Scientific Statement for Health Professionals From the American Heart Association. *Circulation* 2017;135:e927-99.
- Kaushik S, Aydin SI, Derespina KR, et al. Multisystem Inflammatory Syndrome in Children Associated with Severe Acute Respiratory Syndrome Coronavirus 2 Infection (MIS-C): A Multi-institutional Study from New York City. *J Pediatr* 2020;224:24-9.
- Riphagen S, Gomez X, Gonzalez-Martinez C, et al. Hyperinflammatory shock in children during COVID-19 pandemic. *Lancet* 2020;395:1607-8.
- Verdoni L, Mazza A, Gervasoni A, et al. An outbreak of severe Kawasaki-like disease at the Italian epicentre of the SARS-CoV-2 epidemic: an observational cohort study. *Lancet* 2020;395:1771-8.
- Fukuda S, Kaneta M, Miyake M, et al. A case of multisystem inflammatory syndrome in children in a Japanese boy: with discussion of cytokine profile. *Mod Rheumatol Case Rep* 2021;5:442-7.
- Takasago S, Sakai A, Sugiyama M, et al. Case Report: Changes in Cytokine Kinetics During the Course of Disease in a Japanese Patient With Multisystem Inflammatory Syndrome in Children. *Front Pediatr* 2021;9:702318.
- Uchida M, Kashima Y, Mochizuki K, et al. Multisystem Inflammatory Syndrome in Children - A New Syndrome Complicated With Acute Heart Failure Following Severe Acute Respiratory Syndrome Coronavirus 2 (SARS-CoV-2) Infection. *Circ J* 2021;85:948-52.
- Choe YJ, Choi EH, Choi JW, et al. Surveillance of COVID-19-Associated Multisystem Inflammatory Syndrome in Children, South Korea. *Emerg Infect Dis* 2021;27:1196-200.
- Leow OMY, Aoyama R, Chan SM. The evolution of severity of paediatric COVID-19 in Singapore: Vertical transmission and multisystem inflammatory syndrome in children. *Ann Acad Med Singap* 2022;51:115-8.
- Ong SWX, Chiew CJ, Ang LW, et al. Clinical and virological features of Severe Acute Respiratory Syndrome Coronavirus 2 (SARS-CoV-2) Variants of Concern: A Retrospective Cohort Study Comparing B.1.1.7 (Alpha), B.1.351 (Beta), and B.1.617.2 (Delta). *Clin Infect Dis* 2022;75:e1128-36.
- World Health Organization. Multisystem inflammatory syndrome in children and adolescents temporally related to COVID-19: Scientific Brief, 15 May 2020. <https://www.who.int/news-room/commentaries/detail/multisystem-inflammatory-syndrome-in-children-and-adolescents-with-covid-19>. Accessed 15 January 2022.
- Chong CY, Tan NWH, Yung CF, et al. Pediatric Kawasaki Disease Trends Prior to and During COVID-19 Outbreak in Singapore. *J Pediatric Infect Dis Soc* 2021:piab047. doi: 10.1093/jpids/piab047.
- Yung CF, Nadua KD, Oh BK, et al. Epidemiological trends in Kawasaki disease during coronavirus disease-19 in Singapore. *J Pediatr* 2020;226:314-5.
- Tan THY, Toh MPHS, Vasoo S, et al. Coronavirus Disease 2019 (COVID-19): The Singapore Experience. A Review of the First Eight Months. *Ann Acad Med Singap* 2020;49:764-8.
- Ministry of Health, Singapore. Media statement on paediatric MIS-C cases in Singapore, 6 November 2021. <https://www.moh.gov.sg/news-highlights/details/media-statement-on-paediatric-mis-c-cases-in-singapore>. Accessed 21 November 2022.
- Payne AB, Gilani Z, Godfred-Cato S, et al. Incidence of Multisystem Inflammatory Syndrome in Children Among US Persons Infected With SARS-CoV-2. *JAMA Netw Open* 2021;4:e2116420.
- Araf Y, Akter F, Tang YD, et al. Omicron variant of SARS-CoV-2: Genomics, transmissibility, and responses to current COVID-19 vaccines. *J Med Virol* 2022;94:1825-32.
- Abrams JY, Godfred-Cato SE, Oster ME, et al. Multisystem Inflammatory Syndrome in Children Associated with Severe Acute Respiratory Syndrome Coronavirus 2: A Systematic Review. *J Pediatr* 2020;226:45-54.e1.
- Dhar D, Dey T, Samim MM, et al. Systemic inflammatory syndrome in COVID-19-SISCOV study: systematic review and meta-analysis. *Pediatr Res* 2022;91:1334-49.
- Kaushik A, Gupta S, Sood M, Sharma S, et al. A Systematic Review of Multisystem Inflammatory Syndrome in Children Associated With SARS-CoV-2 Infection. *Pediatr Infect Dis J* 2020;39:e340-6.
- Yasuhara J, Watanabe K, Takagi H, et al. COVID-19 and multisystem inflammatory syndrome in children: A systematic review and meta-analysis. *Pediatr Pulmonol* 2021;56:837-48.
- Stierman B, Abrams JY, Godfred-Cato SE, et al. Racial and Ethnic Disparities in Multisystem Inflammatory Syndrome in Children in the United States, March 2020 to February 2021. *Pediatr Infect Dis J* 2021;40:e400-6.
- Government of Singapore. What are the racial proportions among Singapore citizens? 10 December 2019. <https://www.gov.sg/article/what-are-the-racial-proportions-among-singapore-citizens>. Accessed 23 February 2022.
- Zhao Y, Yin L, Patel J, et al. The inflammatory markers of multisystem inflammatory syndrome in children (MIS-C) and adolescents associated with COVID-19: A meta-analysis. *J Med Virol* 2021;93:4358-69.
- Penner J, Abdel-Mannan O, Grant K, et al. 6-month multidisciplinary follow-up and outcomes of patients with paediatric inflammatory multisystem syndrome (PIMS-TS) at a UK tertiary paediatric hospital: a retrospective cohort study. *Lancet Child Adolesc Health* 2021;5:473-82.
- Abrams JY, Oster ME, Godfred-Cato SE, et al. Factors linked to severe outcomes in multisystem inflammatory syndrome in children (MIS-C) in the USA: a retrospective surveillance study. *Lancet Child Adolesc Health* 2021;5:323-31.
- Davies P, du Pré P, Lillie J, et al. One-Year Outcomes of Critical Care Patients Post-COVID-19 Multisystem Inflammatory Syndrome in Children. *JAMA Pediatr* 2021;175:1281-3.



30. Henderson LA, Canna SW, Friedman KG, et al. American College of Rheumatology Clinical Guidance for Multisystem Inflammatory Syndrome in Children Associated With SARS-CoV-2 and Hyperinflammation in Pediatric COVID-19: Version 3. *Arthritis Rheumatol* 2022;74:e1-20.
  31. Ouldali N, Toubiana J, Antona D, et al. French Covid-19 Paediatric Inflammation Consortium. Association of Intravenous Immunoglobulins Plus Methylprednisolone vs Immunoglobulins Alone With Course of Fever in Multisystem Inflammatory Syndrome in Children. *JAMA* 2021;325:855-64. Erratum in: *JAMA* 2021;326:90.
  32. Son MBF, Murray N, Friedman K, et al. Multisystem Inflammatory Syndrome in Children - Initial Therapy and Outcomes. *N Engl J Med* 2021;385:23-34.
  33. Brisca G, Consolaro A, Caorsi R, et al. Timely Recognition and Early Multi-Step Antinflammatory Therapy May Prevent ICU Admission of Patients With MIS-C: Proposal for a Severity Score. *Front Pediatr* 2021;9:783745.
  34. ClinicalTrials.gov. MIS-C Comparative Effectiveness Study (MISTIC). First posted 24 May 2021, updated 6 April 2022. <https://clinicaltrials.gov/ct2/show/NCT04898231>. Accessed 28 July 2022.
  35. Whitworth H, Sartain SE, Kumar R, et al. Rate of thrombosis in children and adolescents hospitalized with COVID-19 or MIS-C. *Blood* 2021;138:190-8.
  36. Goldenberg NA, Sochet A, Albigetti M, et al. Pediatric/Neonatal Hemostasis and Thrombosis Subcommittee of the ISTH SSC. Consensus-based clinical recommendations and research priorities for anticoagulant thromboprophylaxis in children hospitalized for COVID-19-related illness. *J Thromb Haemost* 2020;18:3099-105.
  37. Del Borrello G, Giraudo I, Bondone C, et al. SARS-COV-2-associated coagulopathy and thromboembolism prophylaxis in children: A single-center observational study. *J Thromb Haemost* 2021;19:522-30.
  38. Levy M, Recher M, Hubert H, et al. Multisystem Inflammatory Syndrome in Children by COVID-19 Vaccination Status of Adolescents in France. *JAMA* 2022;327:281-3.
  39. Centers for Disease Control and Prevention. COVID Data Tracker. <https://covid.cdc.gov/covid-data-tracker/#mis-national-surveillance>. Accessed 10 November 2022.
  40. Ministry of Health, Singapore. Child Vaccination, updated 1 November 2022. <https://www.moh.gov.sg/covid-19/vaccination/faqs---children-related-vaccination-matters>. Accessed 10 November 2022.
-

## Improving drug allergy label accuracy by supervised safety- and protocol-driven evaluation

Chiara Jiamin Chong<sup>1</sup>*MRCP*, Karen Jui Lin Choo<sup>2</sup>*MRCP*, Kheng Yong Ong<sup>3</sup>*BSc (Pharm) (Hons)*, Vivian Tan<sup>3</sup>*BSc (Pharm) (Hons)*, Janet Beng Neo Khoo<sup>4</sup>*PG Dip*, Kavitha Garuna Murthee<sup>1</sup>*MRCP*, Ibrahim Muhammad Hanif<sup>5</sup>*MRCP*, Chaw Su Naing<sup>5</sup>*MSc*, Haur Yueh Lee<sup>2</sup>*MRCP*

### ABSTRACT

**Introduction:** Drug allergies are often self-reported but of unknown accuracy. We carried out a prospective study to examine the utility and safety of formal allergology evaluation, and to identify factors associated with accurate drug allergy labels.

**Method:** All patients who underwent drug allergy evaluation in our clinic during the study period were recruited. Baseline demographics, characteristics of index hypersensitivity reaction and outcomes of evaluation were recorded.

**Results:** A total of 331 patients from March 2019 to June 2021 completed drug allergy evaluation to index drugs of concern. There were 123 (37%) male patients, and the mean age was 49 years (standard deviation 17). There were 170 beta-lactam antibiotics, 53 peri-operative drugs, 43 others, 38 non-steroidal anti-inflammatory drugs, and 27 non-beta-lactam antibiotic evaluations. Index reaction occurred within 5 years in 165 (50%) patients, with latency of less than 4 hours in 125 (38%) patients. The most common index reactions were rash, angioedema and urticaria. There were 57 (17%) evaluations stratified as low risk, 222 (67%) moderate risk, and 52 (16%) high risk based on multidisciplinary consensus. Allergy label was found to be false (negative drug evaluation) in 248 (75%) patients, while 16/237 (7%) skin tests, 44/331 (13%) in-clinic graded challenge, and 23/134 (17%) home prolonged challenges were positive (true drug allergy). The most common evaluation reactions were rash and urticaria. No cases of anaphylaxis were elicited.

**Conclusion:** Seventy-five percent of drug allergy labels are inaccurate. Risk-stratified, protocolised allergy evaluation is safe. Prolonged drug challenge increases the sensitivity of drug allergy evaluation and should therefore be performed when indicated.

Ann Acad Med Singap 2022;51:677-85

**Keywords:** Drug allergy, drug hypersensitivity, graded challenge, prolonged drug provocation, skin testing

### INTRODUCTION

Self-reported drug allergies<sup>1</sup> are common, and the majority of these have been shown to be inaccurate. Recording of drug allergy details is also often incomplete and inaccurate.<sup>2</sup> Consequences of inaccurate drug labelling include unnecessary avoidance of effective medications, restricted access to appropriate antibiotics, impact on antimicrobial stewardship, and public health consequences of health economics and utilisation. Beta-lactam allergy labelling results in the use of

broad-spectrum antimicrobials that are more costly and potentially less effective, as well as increase the rates of antimicrobial resistance and susceptibility to *Clostridium difficile* infection.<sup>3-6</sup>

Various interventions have been proposed to address these issues. Measures include: (1) access to formal allergological evaluation; (2) reducing inappropriate drug allergy labelling through physician- and pharmacist-led multidisciplinary teams;<sup>6-9</sup> and (3) point of care direct challenge to penicillin. Formal

<sup>1</sup>Department of Internal Medicine, Singapore General Hospital, Singapore

<sup>2</sup>Department of Dermatology, Singapore General Hospital, Singapore

<sup>3</sup>Department of Pharmacy, Singapore General Hospital, Singapore

<sup>4</sup>Division of Nursing, Singapore General Hospital, Singapore

<sup>5</sup>Department of General Medicine, Sengkang General Hospital, Singapore

Correspondence: Dr Chiara Jiamin Chong, Department of Internal Medicine, Singapore General Hospital, Academia, 20 College Road, Singapore 169856.

Email: chiara.chong.j.m@singhealth.com.sg

## CLINICAL IMPACT

### What is New

- Seventy-five percent of drug allergy labels in an outpatient allergy clinic were found to be inaccurate on evaluation.
- Prolonged drug provocation increases the sensitivity of drug allergy evaluation and should be considered where appropriate.
- A stepwise relationship between pre-evaluation risk prognostication and the likelihood of accurate drug allergy labelling was observed.

### Clinical Implications

- Prolonged drug provocation should be considered if the latency of reaction is delayed or unknown.
- A formal risk prognostication framework should be adopted.
- Drug allergy evaluation is safe, improves therapeutic options, and has important public health consequences.

allergological evaluation of drug allergies includes skin tests, patch tests and graded drug challenges in monitored settings.<sup>10-14</sup> Controlled drug provocation testing to penicillin has been successful in 70.9 to 94.4% of patients<sup>15,16</sup> and alternative drug challenges can also be performed to increase therapeutic options. Although a significant number of drug allergy labels can be removed upon evaluation, the clinical or historical factors associated with a true drug allergy remain unclear.

The primary aim of our study was to examine the outcomes and safety of allergological evaluation of drug allergies in Singapore General Hospital. Our secondary aim was to determine if there are underlying factors that can predict accurate drug allergy labels.

## METHOD

Over the period of March 2019 to June 2021, all patients above 18 years old who attended the Singapore General Hospital's Allergy Centre for drug allergy evaluation were recruited into a prospective observational study. In general, all patients underwent, if appropriate, skin testing consisting of skin prick test and intra-dermal testing as per published protocols according to drug classes.<sup>13,17,18</sup> Specific immunoglobulins for beta-lactam allergy were determined via ImmunoCAP whole

allergens testing (ThermoFisher Scientific Inc, Waltham, US). For reactions that are delayed or of unknown latency, additional patch tests and delayed intra-dermal reading were also performed. If skin tests are negative or unnecessary as per protocol, patients will proceed on to an in-clinic graded challenge under supervision. In patients with delayed/unknown reactions, an additional step of prolonged drug provocation (at home) of 5 days' duration was instituted. Prior history of severe cutaneous adverse drug reactions and pregnancy were contraindicated from any drug testing in our centre.

For certain drugs such as non-steroidal anti-inflammatory drug (NSAID) hypersensitivity, patients were offered either evaluation to index NSAIDs, or alternative evaluation to cyclooxygenase-II inhibitors such as etoricoxib. Shared decision-making was undertaken based on physician and patient preferences.

Prior to evaluation, all patients were risk-stratified during a multidisciplinary meeting consisting of specialty doctors, nurses and pharmacists. Patient stratification was based on consensus and a composite of clinical factors: (1) likelihood of reaction in terms of symptoms, latency, prior reactions and re-exposure post-event; (2) severity of reaction e.g. systemic reactions versus cutaneous; (3) age and underlying comorbidities; and (4) evaluation of responses to index drug versus alternative drug. High-risk patients were assigned to receive continuous monitoring, in the visual sight of nurses, and had intravenous access secured prior to the commencement of evaluation. Moderate- and low-risk patients received standard monitoring every 30 minutes during evaluation. In addition, for certain high-risk patients such as those with a reported history of anaphylaxis, the initial starting concentration of skin tests was reduced.

Upon completion of skin testing and/or graded challenge, all patients were observed for one hour before discharge. In patients who had unclear/or delayed latency to the original reaction, an additional 5-day course of the index drug was prescribed for home administration. Post-evaluation monitoring was also carried out via a 3-pronged method: (1) nurse-led telephone calls one day after clinical evaluation and an additional call on day 3 for those requiring prolonged 5-day drug challenge; (2) direct access to clinics via telephone hotlines and dedicated emails; and (3) same-day clinic review if required. All patients who reported symptoms were reviewed either in person or via video/phone consult. Non-specific itch in the absence of other clinical signs was not regarded as a positive evaluation.

Baseline information such as patient demographics, comorbidities, number of drug allergies and characteristics of index hypersensitivity reaction was

recorded. Evaluation outcomes including hypersensitivity reactions, treatment administered and disposition were also recorded. Safety of allergy evaluation was measured based on the number of anaphylaxis and systemic episodes as well as resuscitation events, unscheduled emergency department visits and hospital admissions.

Our primary aim was to determine the outcomes and risks of drug allergy testing. The secondary aim was to determine any clinical factors that were predictive of a true drug allergy. Analysis was restricted to drug evaluations performed on the index drug, as the evaluation to alternative drugs is safer and does not carry the same risks or outcomes. Similarly, without allergy testing and direct provocation to the labelled drug, a drug allergy cannot be verified.

Statistical analysis was performed using SPSS version 26. Chi-square tests were performed for qualitative variables, student T-tests were undertaken for quantitative variables, and 1-way analysis of variance tests was used for interval variables. *P* values were double-sided with *P*<0.05 taken as statistically significant. Ethical approval was obtained from our institution's research board (Singhealth Centralised Institutional Review Board, IRB number 2018/2877).

## RESULTS

A total of 482 patients were enrolled in our study from March 2019 to June 2021. Of these, 370 were tested for the index drug while 112 were tested for alternative agents. Of those evaluated for the index drug allergy, 331 completed full drug evaluations that included drug provocation and were included for analysis. The rest with incomplete evaluation or non-definitive results were excluded. The patient allocation is summarised in Fig. 1.

The mean age of the studied cohort who underwent full drug allergy evaluation (*n*=331) was 49 years (standard deviation 17) and 123 (37%) were males. Among the patients, 159 (48%) had 0–2 drug allergy labels, 87 (26%) had 3–4 labels, and 85 (26%) had 5 or more existing drug allergy labels at baseline. Beta-lactam antibiotics were the most common drug class evaluated (170/331, 51%), followed by peri-operative drugs (53/331, 16%) and NSAIDs (38/331, 12%) (Table 1).

Time from index reaction to evaluation was less than 6 months in 40 patients (12%), 6–12 months in 49 (15%), 1–5 years in 76 (23%), 5–10 years in 25 (8%), more than 10 years in 102 (31%), and unknown in 39 (12%). The latency of the reaction was less than 4 hours in 125 patients (38%), more than

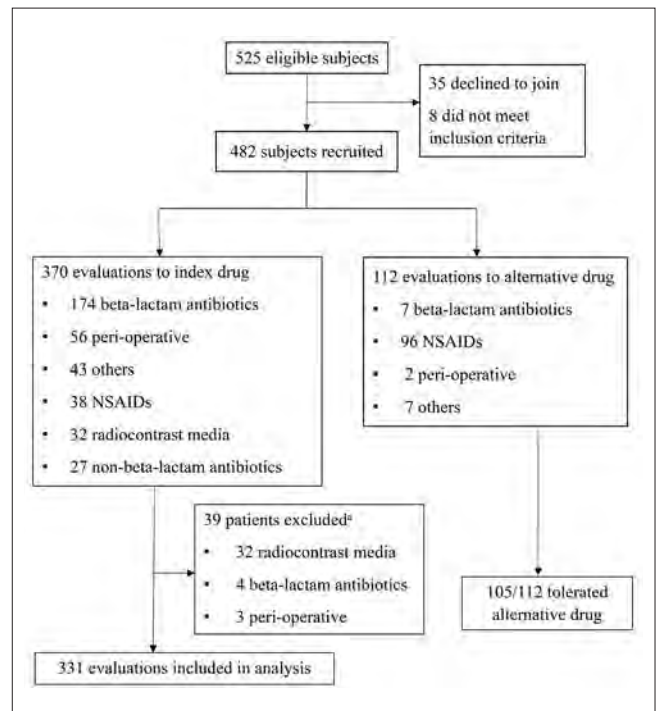

Fig. 1. Study allocation.

NSAIDs: non-steroidal anti-inflammatory drugs

<sup>a</sup> 39 patients were excluded as the evaluation was incomplete or inconclusive

4 hours in 94 (28%), and unknown in 112 (34%). The most common index reactions were rash (133, 40%), angioedema (85, 26%) and urticaria (57, 17%). Systemic reactions were less common: anaphylaxis (28, 9%), isolated respiratory symptoms, e.g. breathlessness, wheezing, globus sensation, chest tightness (27, 8%) and hypotension (13, 4%). Other baseline demographics and characteristics of index hypersensitivity reactions (Table 1) showed that 57 patients (17%) were stratified as low risk, 222 (67%) as moderate risk, and 52 (16%) as high risk.

Among the allergy evaluations to the index drug, 248 patients (75%) who did not develop reactions during drug provocation were deemed to have negative drug evaluations (false drug allergy labels). Eighty-three (25%) who developed reactions either on skin testing or drug provocation were verified to have positive drug evaluation (true drug allergy label).

Out of the 331 drug evaluations performed, the proportions of positive drug evaluation (true drug allergy label) according to drug class are as follows: 56/170 (33%) beta-lactam antibiotics, 13/38 (34%) NSAIDs, 6/43 (14%) others, 5/53 (9%) peri-operative drugs, and 3/27 (11%) non-beta-lactam antibiotics (Table 2). Within the beta-lactam antibiotic class of 170, 56 patients (33%) had positive drug evaluations (true drug allergy labels), 1 (0.6%) developed reactions

Table 1. Baseline demographics of patients undergoing evaluation to index drug

	Total number of evaluations (n=331) No. (%)	Negative drug evaluation (false drug allergy label) (n=248) No. (%)	Positive drug evaluation (true drug allergy label) (n=83) No. (%)	P value
Age, mean (SD), years	49 (17)	49 (17)	49 (15)	0.87
Sex, male	123 (37)	102 (41)	21 (25)	<b>0.01</b>
Sex, female	208 (63)	146 (59)	62 (75)	
<b>Comorbidities</b>				
Angioedema-urticaria	16 (5)	12 (5)	4 (5)	0.99
Atopic dermatitis	16 (5)	10 (4)	6 (7)	0.24
Cardiac <sup>a</sup>	128 (39)	89 (36)	39 (47)	0.07
Respiratory <sup>b</sup>	42 (13)	33 (13)	9 (11)	0.56
<b>No. of pre-existing drug allergies</b>				<b>0.70</b>
0–2	159 (48)	119 (48)	40 (48)	
3–4	87 (26)	68 (27)	19 (23)	
≥5	85 (26)	61 (25)	24 (29)	
<b>Class of drug evaluated</b>				<b>&lt;0.01</b>
Beta-lactam antibiotics	170 (51)	114 (46)	56 (68)	
Peri-operative drugs	53 (16)	48 (19)	5 (6)	
NSAIDs	38 (12)	25 (10)	13 (16)	
Non-beta-lactam antibiotics <sup>c</sup>	27 (8)	24 (10)	3 (4)	
Others <sup>d</sup>	43 (13)	37 (15)	6 (7)	
<b>Time from reaction to evaluation</b>				<b>0.85</b>
<6 months	40 (12)	32 (13)	8 (10)	
6–12 months	49 (15)	35 (14)	14 (17)	
1–5 years	76 (23)	53 (21)	23 (28)	
5–10 years	25 (8)	20 (8)	5 (6)	
>10 years	102 (31)	80 (32)	22 (27)	
Unknown	39 (12)	28 (11)	11 (13)	
<b>Latency</b>				<b>0.19</b>
<4 hours	125 (38)	89 (36)	35 (43)	
>4 hours	94 (28)	71 (29)	23 (28)	
Unknown	112 (34)	88 (35)	24 (29)	
<b>Type of index reaction</b>				
Rash not otherwise specified	133 (40)	99 (40)	34 (41)	0.87
Angioedema	85 (26)	58 (23)	27 (33)	0.10
Urticaria	57 (17)	42 (17)	15 (18)	0.81
Itch	48 (15)	35 (14)	13 (16)	0.73



Table 1. Baseline demographics of patients undergoing evaluation to index drug (Cont'd)

	Total number of evaluations (n=331) No. (%)	Negative drug evaluation (false drug allergy label) (n=248) No. (%)	Positive drug evaluation (true drug allergy label) (n=83) No. (%)	P value
Anaphylaxis	28 (9)	22 (9)	6 (7)	0.64
Unknown	30 (9)	21 (9)	9 (11)	0.51
Respiratory <sup>e</sup>	27 (8)	21 (9)	6 (7)	0.72
Isolated hypotension	13 (4)	9 (4)	4 (5)	0.63
Others <sup>f</sup>	33 (10)	26 (11)	7 (8)	0.59
<b>Pre-evaluation risk stratification</b>				<b>&lt;0.01</b>
Low	57 (17)	50 (20)	7 (8)	
Moderate	222 (67)	172 (69)	50 (60)	
High	52 (16)	26 (11)	26 (31)	

NSAIDs: non-steroidal anti-inflammatory drugs; SD: standard deviation

<sup>a</sup>Cardiac comorbidities including hypertension, hyperlipidaemia, ischaemic heart disease.

<sup>b</sup>Respiratory comorbidities including asthma, allergic rhinitis.

<sup>c</sup>Non-beta-lactam antibiotics: macrolides = 9, fluoroquinolones = 9, metronidazole = 7, vancomycin = 1, tetracycline = 1.

<sup>d</sup>Other drugs evaluated: proton pump inhibitors = 8; opioids = 7; anti-emetics = 5; corticosteroids = 3; anti-hypertensives, anti-platelet, mecobalamin/cyanobalamin, statins, antihistamines = 2 each; anti-tussives, allopurinol, somatotropin, anti-spasmodic, insulin, mesalazine, colchicine, levodopa-benserazide, diuretic, erythropoietin = 1 each.

<sup>e</sup>Respiratory reactions including breathlessness, wheezing, globus sensation, chest tightness.

<sup>f</sup>Other index reactions: gastrointestinal = 9; fixed drug eruption or blisters = 3; erythema or flushing, rhinorrhoea/lacrimation/chemosis, syncope = 3 each; myoclonic jerks, giddiness, palpitations, fever/chills = 2 each; lethargy, diaphoresis, paraesthesia, pain, family history of allergy = 1 each.

on the skin prick test, 9 (5%) on the intra-dermal test, and 25 (15%) during the in-clinic graded challenge. Prolonged drug challenge was deemed necessary in 102 patients, and 21 of these (21%) developed reactions during the home prolonged challenge. Within the peri-operative drugs, 5/53 patients (9%) had positive drug evaluations (true drug allergy labels), 3/53 (6%) reacted during the intra-dermal test, and 2/53 (4%) reacted during the in-clinic graded challenge. Within the NSAID class, 13/38 patients (34%) had positive drug evaluations (true drug allergy labels), while 12/38 (32%) developed reactions following in-clinic graded challenge, and 1/3 (33%) developed reactions following prolonged drug challenge. For patients who were evaluated to non-beta-lactam antibiotics, 3/27 (11%) had positive drug evaluations (true drug allergy labels), 2/27 (7%) reacted during the in-clinic graded challenge and 1/18 (6%) developed reactions during home prolonged evaluation.

Positive drug evaluations by step of evaluation occurred as follows: 16/237 (7%) skin tests, 44/331 (13%) in-clinic graded challenge, and 23/134 (17%) prolonged home challenge. Among the patients who developed reactions during their 5-day home prolonged

challenge, 2 developed reactions on day 1; 5 each on day 2 and 3; 1 on day 4; 2 on day 5; and 6 on day 6 (Table 2).

The most common elicited reactions during both in-clinic graded challenge and home prolonged evaluations in the 83 patients were 26 unspecified rashes (31%) (13 during the in-clinic graded challenge and 13 during home prolonged evaluation) and 21 urticaria (26%) (18 during the in-clinic graded challenge and 3 during home prolonged evaluation) (Table 3). Two patients developed systemic reactions requiring admission. There were no anaphylactic reactions observed during the evaluation.

For those who developed reactions on testing, 40/83 patients (48%) (27 during the in-clinic graded challenge and 13 during home prolonged evaluation) required antihistamines for their hypersensitivity reactions; 39/83 (47%) (29 during the in-clinic graded challenge and 10 during the home prolonged challenge) did not require any treatment. Nine out of 83 patients (11%) (7 during in-clinic graded challenge and 2 during home prolonged evaluation) required intravenous or oral corticosteroids (Table 3). Nine (11%) who developed reactions during home prolonged evaluation required

early clinic reviews. Two (2%) required inpatient admission after in-clinic graded challenge for closer monitoring. The first patient developed angioedema, breathlessness and globus sensation after ibuprofen evaluation. He received oral and systemic antihistamines, and oral corticosteroids in the clinic, and was admitted for airway monitoring as he had morbid obesity. He remained well inpatient. The second patient developed acute generalised exanthematous pustulosis after systemic penicillin evaluation for an unknown childhood reaction. She was admitted for monitoring and systemic corticosteroids, and improved inpatient with treatment. There were no cases of unscheduled emergency department attendances for post-challenge reactions. Seven out of 57 (12%) low-risk patients, 50/222 (23%) moderate-risk patients, and 26/52 (50%) high-risk patients were proven to have true allergy labels ( $P<0.01$ ) (Fig. 2).

Secondary analysis showed that sex ( $P=0.01$ ), class of drug evaluated ( $P<0.01$ ), and pre-evaluation risk prognostication ( $P<0.01$ ) were significant for the outcome of evaluation ( $P<0.01$ ).

All other baseline demographics, atopic comorbidity, clinical characteristics of index reaction, and time to evaluation were not predictive of true drug allergy (Table 1).

## DISCUSSION

Our study has shown that the majority of drug allergy labels are inaccurate. With formal allergological evaluations, more than 75% of drug allergy labels can be safely removed. In addition, we have demonstrated the utility of prolonged drug challenges in allergy evaluation, particularly in individuals with non-immediate reactions or reactions with unknown latency. Protocolised, supervised drug allergy testing is safe with rare systemic reactions (2/331, 0.6%) and no anaphylaxis is reported in our test cohort of 482 patients.

In our cohort, 83/331 (25%) were verified to have true drug hypersensitivity following systematic drug allergy evaluation. Positive results (true drug allergy) were seen in 16/237 (7%) skin tests, 44/331 (13%) in-clinic graded challenges, and 23/134 (17%) home prolonged challenges. These findings validated the utility of a stepwise protocolised approach to drug allergy validation. Firstly, such an approach allowed the removal of allergy labels in most patients. Secondly, 7% of skin testing (consisting of skin prick tests and intra-dermal testing) was positive and patients avoided the need and risks associated with direct oral provocation. Although direct drug provocation has been recommended as an alternative approach, particularly in low-risk patients and in settings where

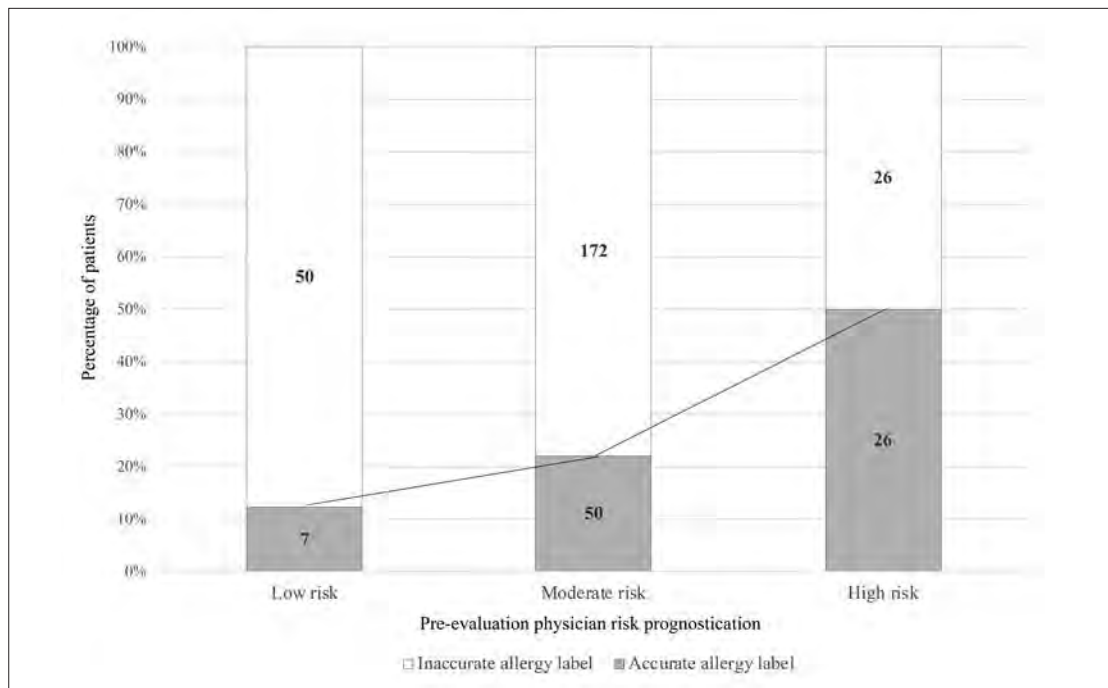

Fig. 2. Pre-evaluation physician risk prognostication and accuracy of allergy labels. A stepwise relationship was found between pre-test risk and the accuracy of drug allergy labels. 7/57 (12%) low-risk, 50/222 (23%) moderate-risk, and 26/52 (50%) high-risk patients were proven to have true allergy labels ( $P<0.01$ ).

Table 2. Outcomes of drug allergy evaluation

Drug class (n=331) No. (%)	Negative drug evaluation (false drug allergy label) (n=248) No. (%)	Positive drug evaluation (true drug allergy label) (n=83) No. (%)	Number of positive evaluations <sup>a</sup>			
			Skin testing		In-clinic graded challenge (n=331) No. (%) <sup>b</sup>	Home prolonged evaluation (n=134) No. (%) <sup>b</sup>
			Skin prick test (n=237) No. (%) <sup>b</sup>	Intra- dermal test (n=237) No. (%) <sup>b</sup>		
Beta-lactam antibiotics 170 (51)	114 (46)	56 (68)	1/170 (0.4)	9/170 (4)	25/170 (8)	21/102 (16) <sup>c</sup>
Peri-operative drugs 53 (16)	48 (19)	5 (6)	0/53 (0)	3/53 (1)	2/53 (0.6)	0
NSAIDs 38 (12)	25 (10)	13 (16)	0	0	12/38 (4)	1/3 (0.7) <sup>d</sup>
Non-beta-lactam antibiotics 27 (8)	24 (10)	3 (4)	0/3 (0)	0/3 (0)	2/27 (0.6)	1/18 (0.7) <sup>e</sup>
Others 43 (13)	37 (15)	6 (7)	0/11 (0)	3/11 (1)	3/43 (0.9)	0/11 (0)
Total	248 (100)	83 (100)	1 (0.4)	15 (6)	44 (13)	23 (17)

NSAIDs: non-steroidal anti-inflammatory drugs

<sup>a</sup> Number of positive evaluations out of total number of evaluations done per drug class.

<sup>b</sup> Percentage calculated using denominator of total number of evaluations performed across all drug classes (column percentage).

<sup>c</sup> Among the 21 reactions that occurred in beta-lactam antibiotics prolonged evaluations, 2 occurred on day 1, 5 on day 2, 5 on day 3, 1 on day 4, 2 on day 5, and 6 on day 6.

<sup>d</sup> Delayed reaction occurred on day 2.

<sup>e</sup> Delayed reaction occurred on day 3.

allergology service is not readily available,<sup>19,20</sup> such an approach, obviating prior skin testing, may be risky. Thirdly, prolonged drug challenges increased the sensitivity of drug allergy evaluation.

Although prolonged drug provocation has been advocated to increase the sensitivity of drug allergy evaluation, particularly in non-immediate reactions<sup>21</sup> occurring in adults, it is not uniformly adopted. If the prolonged challenge were omitted, up to 23/83 (28%) of patients with true drug allergies would have been missed and their drug allergy labels erroneously removed based on our findings. Similar findings have also been reported by Hjortlund et al.—10 out of 291 patients had positive single-dose challenges, but a further 23 patients went on to develop positive evaluations on 7-day challenges.<sup>16</sup> Fransson et al. found that in direct drug allergy provocation of patients without prior skin testing, 11% of the study population (n=1,913) had positive challenges: 20% of these positive provocations were positive on the first dose, whereas 45% were positive more than 3 days later, reinforcing the need for prolonged challenges. The rationale behind prolonged drug challenge lies in the fact that drug hypersensitivity reactions consist of both immediate and non-immediate reactions (such as

drug exanthems), with the latter requiring prolonged exposure to a drug before the allergic reaction occurs. Similarly, a longer exposure to the culprit drug may be required to elicit the allergic response in drug allergy evaluation.

A secondary analysis was performed to determine any underlying demographics, clinical history or other factors that could predict true drug allergy labels. Subjects who were female ( $P=0.01$ ) or who had beta-lactam evaluation ( $P<0.01$ ) were more likely to have true drug allergy labels. Factors such as age, comorbidities, number of drug allergies, clinical presentation, latency and time to evaluation were not found to be significant ( $P>0.05$ ). Similar conclusions were reached in a French study, which was unable to derive a predictive model based on allergist-collected history.<sup>23</sup> These findings reinforce the inaccuracy of drug allergy history and behave the need for a formal drug allergy evaluation.

In our centre, a multidisciplinary meeting between physicians, pharmacists and nurses is convened prior to actual drug allergy evaluation sessions. This allows for discussions on the suitability for evaluation based on patients' comorbidities, assigning the appropriate challenge protocol as well as risk prognostication. Risk

Table 3. Breakdown of reactions encountered following in-clinic graded challenge or prolonged home challenge

	In-clinic graded challenge (n=60) No. (%)	Home prolonged evaluation (n=23) No. (%)
Type of reaction <sup>a</sup>		
Rash	13 (30)	13 (57)
Urticaria	18 (41)	3 (13)
Angioedema	11 (25)	7 (30)
Respiratory <sup>b</sup>	9 (20)	4 (17)
Anaphylaxis	0	0
Others <sup>c</sup>	12 (27)	6 (26)
Treatment administered <sup>d</sup>		
Antihistamine	27 (61)	13 (57)
Nil treatment	29 (66)	10 (43)
Intravenous/oral corticosteroid	7 (16)	2 (9)
Adrenaline	0	0
Others <sup>d</sup>	5 (11)	6 (26)

<sup>a</sup>Patients may experience more than one sign and symptom; hence total number of reactions and treatments administered is more than the number of patients in each group.

<sup>b</sup>Respiratory reactions including breathlessness, wheezing, globus sensation, chest tightness, changes in voice.

<sup>c</sup>Other types of reactions encountered in both in-clinic graded challenge and prolonged home challenge: lacrimation, blurring of vision, conjunctiva injection = 5, gastrointestinal = 4, dysaesthesia, numbness = 3, central nervous system = 2, chills and rigours, lower limb oedema, desquamation, discomfort = 1 each.

<sup>d</sup>Other treatment administered in both in-clinic graded challenge and prolonged home challenge: topical creams (anti-pruritic, corticosteroid, emollients) = 6, intravenous hydration = 2, anti-emetic, paracetamol, albuterol and ipratropium combination inhaler = 1 each.

prognostication is essential for patient counselling, appropriate monitoring as well as allocation of manpower and resources. In addition, there was also a stepwise relationship between the pre-test risk and the likelihood of true drug allergy. Seven (12%) low-risk patients, 50 (23%) moderate-risk patients, and 26 (50%) high-risk patients were proven to have true allergy labels ( $P < 0.01$ ). In a risk-stratified, protocolised setting, drug allergy evaluation is safe.<sup>24,25</sup> There were no cases of anaphylaxis, and common hypersensitivity reactions were unspecified rash (26/83, 31%) and urticaria (21/83, 26%). Most patients (40/83, 48%) required only antihistamines or no rescue treatment at all (39/83, 47%). Nine patients (11%) required early clinic review and only 2 (2%) patients were admitted for closer monitoring. The 2 patients who required admission were each deemed to be moderate risk and high risk, and both were discharged uneventfully after the resolution of their hypersensitivity reactions.

The limitations of our study include referral bias, as the patients seen in our tertiary centre often have multiple comorbidities and are subject to polypharmacy.

However cardiac, respiratory, and atopic comorbidities and the number of drug allergy labels pre-evaluation were not found to be significant in predicting the outcomes of allergy evaluation. Pre-evaluation risk stratification by our multidisciplinary team was based on consensus after discussing patient factors and characteristics of index reaction. In our study, some patients with skin tests only did not undergo further confirmatory drug provocation, thus the possibility of false positives cannot be excluded. However, such a practice is consistent with current best practices.<sup>10</sup> Lastly, patients who underwent allergy evaluation in relation to peri-operative drugs did not receive graded intravenous provocative challenge due to lack of anaesthesia support, and were excluded from statistical analysis.

## CONCLUSION

Many drug allergy labels are untrue and drug allergy evaluation is essential in verifying them. In a risk-stratified, protocolised setting, drug allergy evaluation is safe and the hypersensitivity reactions observed were mostly cutaneous in nature. Prolonged

drug provocation testing, where indicated, increases the sensitivity of drug allergy evaluation and is important in the verification of allergy labels.

#### Acknowledgements

We thank all other nurses, doctors and staff of Immunohub for their assistance and support of the study.

#### REFERENCES

- Sousa-Pinto B, Fonseca JA, Gomes ER. Frequency of self-reported drug allergy: A systematic review and meta-analysis with meta-regression. *Ann Allergy Asthma Immunol* 2017;119:362-73.e2.
- Gay KJ, Hill C, Bell T. Accuracy of drug-allergy recording in a district general hospital. *Int J Pharm Pract* 2009;17:253-5.
- Blumenthal KG, Lu N, Zhang Y, et al. Risk of meticillin resistant *Staphylococcus aureus* and *Clostridium difficile* in patients with a documented penicillin allergy: population based matched cohort study. *BMJ* 2018;361:k2400.
- Blumenthal KG, Peter JG, Trubiano JA, et al. Antibiotic allergy. *Lancet* 2019;393:183-98.
- Blumenthal KG, Oreskovic NM, Fu X, et al. High-cost, high-need patients: the impact of reported penicillin allergy. *Am J Manag Care* 2020;26:154-61.
- Stone CA, Trubiano J, Coleman DT, et al. The challenge of de-labeling penicillin allergy. *Allergy* 2020;75:273-88.
- Bourke J, Pavlos R, James I, et al. Improving the Effectiveness of Penicillin Allergy De-labeling. *J Allergy Clin Immunol Pract* 2015;3:365-74.e1.
- Devchand M, Kirkpatrick CMJ, Stevenson W, et al. Evaluation of a pharmacist-led penicillin allergy de-labelling ward round: a novel antimicrobial stewardship intervention. *J Antimicrob Chemother* 2019;74:1725-30.
- du Plessis T, Walls G, Jordan A, et al. Implementation of a pharmacist-led penicillin allergy de-labelling service in a public hospital. *J Antimicrob Chemother* 2019;74:1438-46.
- Romano A, Atanaskovic-Markovic M, Barbaud A, et al. Towards a more precise diagnosis of hypersensitivity to beta-lactams — an EAACI position paper. *Allergy* 2020;75:1300-15.
- Richter AG, Nasser SM, Krishna MT. A UK national survey of investigations for beta-lactam hypersensitivity – heterogeneity in practice and a need for national guidelines – on behalf of British Society for Allergy and Clinical Immunology (BSACI). *Clin Exp Allergy* 2013;43:941-9.
- Blanca M, Romano A, Torres MJ, et al. Update on the evaluation of hypersensitivity reactions to betalactams. *Allergy* 2009;64:183-93.
- Mirakian R, Leech SC, Krishna MT, et al. Management of allergy to penicillins and other beta-lactams. *Clin Exp Allergy* 2015 Feb;45:300-27.
- Torres MJ, Blanca M, Fernandez J, et al. Diagnosis of immediate allergic reactions to beta-lactam antibiotics. *Allergy* 2003;58:961-72.
- DesBiens M, Scalia P, Ravikumar S, et al. A Closer Look at Penicillin Allergy History: Systematic Review and Meta-Analysis of Tolerance to Drug Challenge. *Am J Med* 2020;133:452-462.e4.
- Hjortlund J, Mortz CG, Skov PS, et al. Diagnosis of penicillin allergy revisited: the value of case history, skin testing, specific IgE and prolonged challenge. *Allergy* 2013;68:1057-64.
- Messaad D, Sahla H, Benahmed S, et al. Drug provocation tests in patients with a history suggesting an immediate drug hypersensitivity reaction. *Ann Intern Med* 2004;140:1001-6.
- Brockow K, Garvey LH, Aberer W, et al. Skin test concentrations for systemically administered drugs - an ENDA/EAACI Drug Allergy Interest Group position paper. *Allergy* 2013;68:702-12.
- Iammatteo M, Alvarez Arango S, Ferastraoraru D, et al. Safety and Outcomes of Oral Graded Challenges to Amoxicillin without Prior Skin Testing. *J Allergy Clin Immunol Pract* 2019;7:236-43.
- Tucker MH, Lomas CM, Ramchandrar N, et al. Amoxicillin challenge without penicillin skin testing in evaluation of penicillin allergy in a cohort of Marine recruits. *J Allergy Clin Immunol Pract* 2017;5:813-5.
- Fransson S, Mosbech H, Kappel M, et al. The Importance of Prolonged Provocation in Drug Allergy - Results From a Danish Allergy Clinic. *J Allergy Clin Immunol Pract* 2017;5:1394-401.
- Eaddy Norton A, Broyles AD. Drug allergy in children and adults: Is it the double X chromosome? *Ann Allergy Asthma Immunol* 2019;122:148-55.
- Chiriac AM, Wang Y, Schrijvers R, et al. Designing Predictive Models for Beta-Lactam Allergy Using the Drug Allergy and Hypersensitivity Database. *J Allergy Clin Immunol Pract* 2018; 6:139-48.e2.
- Kao L, Rajan J, Roy L, et al. Adverse reactions during drug challenges: a single US institution's experience. *Ann Allergy Asthma Immunol* 2013;110:86-91.e1.
- Thalayasingam M, Davies LJ, Llanora GV, et al. Clinical Characteristics and Outcomes of Patients Undergoing Drug Provocation Tests (DPTs). *Ann Acad Med Singap* 2013;42:184-9.



## Non-alcoholic fatty liver disease screening in type 2 diabetes mellitus: A cost-effectiveness and price threshold analysis

Bryan Peide Choo<sup>1</sup>*MPH*, George Boon-Bee Goh<sup>2,3</sup>*MBBS*, Sing Yi Chia<sup>4</sup>*BSc*, Hong Choon Oh<sup>1,3,5</sup>*PhD*,  
Ngiap Chuan Tan<sup>3,6</sup>*FCFPs*, Jessica Yi Lyn Tan<sup>7</sup>*MBBS*, Tiing Leong Ang<sup>3,7</sup>*FRCP*, Yong Mong Bee<sup>3,8</sup>*MBBS*, Yu Jun Wong<sup>3,7</sup>*FRCP*

### ABSTRACT

**Introduction:** The cost-effectiveness of screening asymptomatic non-alcoholic fatty liver disease (NAFLD) patients remains debatable, with current studies assuming lifelong benefits of NAFLD screening while neglecting cardiovascular outcomes. This study aims to assess the cost-effectiveness of NAFLD screening among type 2 diabetes mellitus (T2DM) patients, and to establish a price threshold for NAFLD treatment, when it becomes available.

**Method:** A Markov model was constructed comparing 4 screening strategies (versus no screening) to identify NAFLD with advanced fibrosis among T2DM patients: fibrosis-4 (FIB-4), vibration-controlled transient elastography (VCTE), FIB-4 and VCTE (simultaneous), and FIB-4 and VCTE (sequential). Sensitivity analyses and price threshold analyses were performed to assess parameter uncertainties in the results.

**Results:** VCTE was the most cost-effective NAFLD screening strategy (USD24,727/quality-adjusted life year [QALY]), followed by FIB-4 (USD36,800/QALY), when compared to no screening. Probabilistic sensitivity analysis revealed a higher degree of certainty for VCTE as a cost-effective strategy compared to FIB-4 (90.7% versus 73.2%). The duration of expected screening benefit is the most influential variable based on incremental cost-effectiveness ratio tornado analysis. The minimum duration of screening benefit for NAFLD screening to be cost-effective was at least 2.6 years. The annual cost of NAFLD treatment should be less than USD751 for NAFLD screening to be cost-effective.

**Conclusion:** Both VCTE and FIB-4 are cost-effective NAFLD screening strategies among T2DM patients in Singapore. However, given the lack of access to VCTE at primary care and potential budget constraints, FIB-4 can also be considered for NAFLD screening among T2DM patients in Singapore.

Ann Acad Med Singap 2022;51:686-94

**Keywords:** Cost-effectiveness analysis, fatty liver, screening, liver fibrosis, population health

### INTRODUCTION

Non-alcoholic fatty liver disease (NAFLD) is a growing epidemic and has become a major cause of liver-related mortality and indication for liver transplantations globally. It is estimated that nearly 25% of the world's population and more than 60% of type 2 diabetes mellitus (T2DM) patients have NAFLD. A prior study demonstrated a high prevalence of NAFLD with

advanced fibrosis among T2DM patients in Singapore.<sup>1</sup> The disease burden of NAFLD in the Singapore population is projected to rise from 1,492,000 to 1,799,000 from 2019 to 2030.<sup>2</sup> This increasing burden of NAFLD is alarming because NAFLD can progress to liver cirrhosis, hepatocellular carcinoma (HCC), and death. Unfortunately, NAFLD is often under-recognised because most patients are either asymptomatic or do not

<sup>1</sup>Health Services Research, Changi General Hospital, Singapore

<sup>2</sup>Department of Gastroenterology & Hepatology, Singapore General Hospital, Singapore

<sup>3</sup>Duke-NUS Medical School, Singapore

<sup>4</sup>Health Services Research, Singapore General Hospital, Singapore

<sup>5</sup>Centre for Population Health Research & Implementation, SingHealth Office of Regional Health, Singapore

<sup>6</sup>SingHealth Polyclinics, Singapore

<sup>7</sup>Department of Gastroenterology & Hepatology, Changi General Hospital, Singapore

<sup>8</sup>Department of Endocrinology, Singapore General Hospital, Singapore

Correspondence: Dr Yu Jun Wong, Department of Gastroenterology & Hepatology, Changi General Hospital, 2 Simei Street 3, Singapore 529889.

Email: [eugene.wong.y.j@singhealth.com.sg](mailto:eugene.wong.y.j@singhealth.com.sg)

## CLINICAL IMPACT

### What is New

- This study compares several non-invasive screening modalities including fibrosis-4 and vibration-controlled transient elastography to identify the most cost-effective strategy for risk stratifying non-alcoholic fatty liver disease (NAFLD) patients.
- The model also incorporates cardiovascular outcome and NAFLD-specific estimates from the latest literature.

### Clinical Implications

- The annual cost of NAFLD treatment estimated will provide clinicians useful information when considering the cost-effectiveness of a screening strategy.
- Findings may aid in deciding the screening modality adopted for NAFLD screening in the primary care setting.

have elevated liver enzymes. Without screening, it is challenging to detect NAFLD patients with significant fibrosis or non-alcoholic steatohepatitis (NASH). Given the high NAFLD prevalence and higher risk of NAFLD progression among T2DM patients, risk stratification is crucial to stratifying patients for subsequent management, without overwhelming the tertiary care setting.

Growing evidence supports the use of fibrosis markers for risk-stratification of NAFLD and cirrhosis patients because fibrosis is the strongest predictor for mortality<sup>3</sup> and long-term outcomes in NAFLD patients.<sup>4</sup> Liver-related mortality increased exponentially with each fibrosis stage. While liver biopsy is currently the gold standard for diagnosis and fibrosis staging of NAFLD, it cannot be used as a screening tool due to its invasiveness and its variability in sampling and interpretation. Non-invasive tests are important for large-scale, population-based screening and risk stratification of NAFLD patients. A 2-tier screening strategy that combines different non-invasive tests has been shown to improve the risk stratification of Asian NAFLD patients.<sup>5</sup> Proper risk stratification of NAFLD patients in the primary care setting has been shown to reduce unnecessary referrals to tertiary care.

Screening is important for identifying high-risk NAFLD patients for early interventions such as intensive

lifestyle modification, pharmacological therapy or bariatric surgery.<sup>6</sup> While lifestyle modification alone may be sufficient for those without advanced fibrosis or NASH, NAFLD patients with advanced fibrosis should be referred to tertiary care and encouraged to consider clinical trials for new therapies or more aggressive interventions such as bariatric surgery. Non-invasive screening strategies using fibrosis-4 (FIB-4) scoring and vibration-controlled transient elastography (VCTE) have been proposed.<sup>7</sup> While the cost-effectiveness of NAFLD screening has been explored, these studies had several shortcomings. First, cardiovascular complications such as ischaemic heart disease and stroke were not considered in the earlier models. Second, screening strategies were assumed to confer lifelong benefits, which may overestimate the benefits of NAFLD screening. Third, the health-state utilities (provides quantitative measures of how strongly a person values a certain health state, ranging from 0 to 1) and cost were often derived from studies conducted in other chronic liver diseases such as chronic hepatitis C or expert opinion. Meanwhile, current guidelines have conflicting views on the recommendations for NAFLD screening.<sup>8-10</sup> To address these gaps, our primary aim was to compare the cost-effectiveness of different strategies for NAFLD screening in the primary care setting. Our secondary aim was to estimate the optimal cost of NAFLD treatment, at which it would be considered cost-effective in the setting of NAFLD screening.

## METHOD

### Overview

A cost-effectiveness analysis was undertaken to estimate the relevant costs and health outcomes of NAFLD screening to prevent further progression of NAFLD to liver cirrhosis or HCC compared with current care, defined as no screening. In the screening arm, all T2DM subjects were offered a once-off screening ultrasound at age 50 to diagnose NAFLD. Subjects diagnosed with NAFLD subsequently undergo fibrosis screening strategies, which include: (1) FIB-4 screening (FIB-4 > 3.25), (2) VCTE screening, (3) FIB-4 and VCTE simultaneous screening, and (4) FIB-4 and VCTE sequential screening. Both sequential and simultaneous testing using non-invasive tests were considered because they have been shown to improve the risk stratification and reduce the misclassification of NAFLD patients, when compared to single-step non-invasive testing.<sup>7</sup> Advanced fibrosis was defined as FIB-4 > 3.25 or VCTE  $\geq$  15kPa based on published

literature.<sup>7</sup> In sequential testing, patients were subjected to 2-tier testing, with those having a FIB-4 index beyond 3.25 subjected to further screening using VCTE. In simultaneous testing, patients were subjected to both FIB-4 and VCTE testing, with either test reflecting a positive result indicative of advanced fibrosis. Our model also accounted for the additional cost that resulted from misclassifying patients into advanced fibrosis during the first year of screening.

Following the diagnosis of advanced fibrosis, these subjects will undergo an intensive weight reduction and lifestyle programme, where evidence for hepatic fibrosis regression had been demonstrated in a prior study.<sup>6</sup> The lifetime time horizon was chosen to model the long-term outcomes of NAFLD that included cardiovascular outcomes, cirrhosis, HCC and liver transplantation. This study was undertaken using the providers' perspective, where once-off screening is adopted for T2DM patients aged 50 years. The age cut-off of 50 years- was chosen for 2 reasons: this is the age threshold recommended by clinical practice guidelines,<sup>10</sup> and recent study showing a threshold effect (where the vast majority of patients begin developing liver-related events such as cirrhosis after 50 years old) among T2DM patients with NAFLD.<sup>11</sup> Findings were reported using incremental cost-effectiveness ratios (ICERs) in US dollars (USD) per quality-adjusted life year (QALY) gained. The interpretation of the cost-effectiveness of the findings was based on the willingness to pay (WTP) of USD50,000/QALY. We extracted NAFLD-specific estimates and utility data, the prevalence of liver and cardiovascular events (acute myocardial infarction, congestive cardiac failure, transient ischaemic attack,

and stroke) and background mortality among diabetic patients aged 50 years and above from the SingHealth Diabetes Registry. The SingHealth Diabetes Registry is a comprehensive registry consisting of 208,102 T2DM patients from 8 healthcare sites within SingHealth, the largest health cluster in Singapore.<sup>12</sup>

### Input parameters

All input parameters were summarised in the online Supplementary Table S1. The prevalence of liver and cardiovascular events and background mortality among diabetic patients aged 50 years and above were extracted from the SingHealth Diabetes Registry. The model was complemented with published literature on the: (1) prevalence and severity of NAFLD patients,<sup>1,13</sup> (2) prevalence and utility of liver and cardiovascular events among NAFLD patients,<sup>14-18</sup> (3) performance of FIB-4 and VCTE,<sup>7,19,20</sup> (4) transition probability of NAFLD health states,<sup>2,7,15,21-24</sup> and (5) NAFLD-specific health state utility.<sup>22</sup> We obtained NAFLD-specific, direct medical costs for different health states from the data of SingHealth hospitals. The cost of liver transplantation and HCC was supplemented with published Singapore literature, adjusted for inflation at a rate of 3% per annum. A discount rate of 3% was used for both costs and health outcomes.

### Economic model

A Markov model was developed with a 1-year cycle length to capture long-term health outcomes (Fig. 1). Patients with NAFLD with advanced fibrosis could either progress to liver cirrhosis, or regress to NAFLD with mild fibrosis (F0-F1). Fibrosis regression may

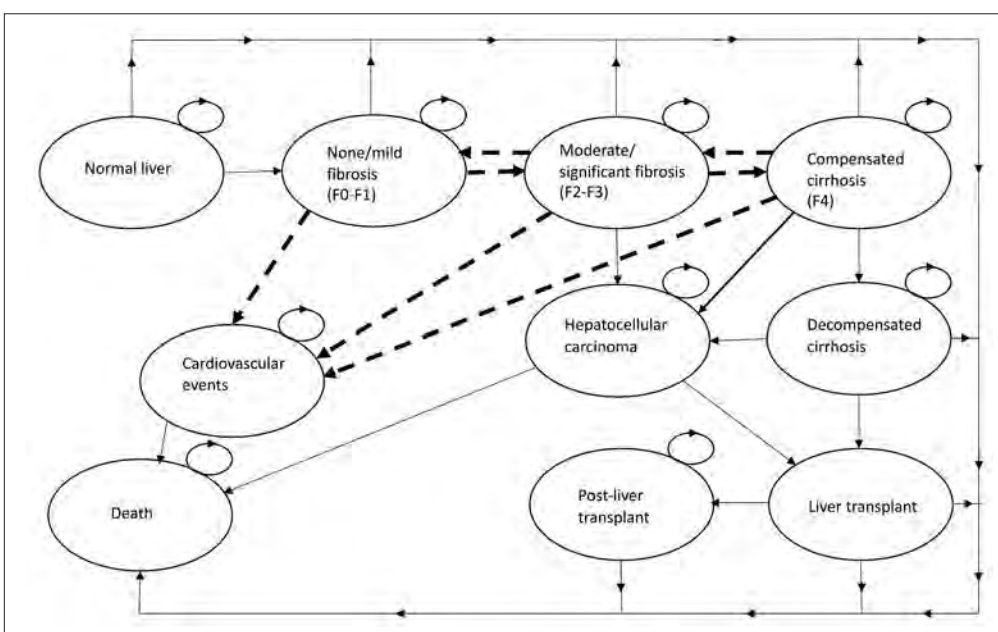

Fig. 1. Markov schematic capturing the main health states adopted in the model, with dotted arrows indicating the impact of screening, coupled with intensive weight loss and dieting on the respective progression and regression rates.

occur in patients with compensated NASH cirrhosis, and was associated with lower liver-related events, as shown in a recent study by Sanyal et al.<sup>25</sup> Patients beyond advanced fibrosis may progress to HCC. Those with HCC and decompensated cirrhosis may progress to having a liver transplant and subsequently remain in the post-liver transplant health state. Cardiovascular events may occur in all stages of NAFLD, except for patients with decompensated cirrhosis and HCC, where the risk of mortality is primarily driven by the underlying liver disease.<sup>26</sup> All health states could result in death through either progression of liver or cardiovascular disease.

**Cost-effectiveness analysis**

For base-case analysis, which is the baseline analysis without consideration of possible changes in variables adopted in the model, we calculated the expected clinical outcomes and lifetime costs of T2DM patients without NAFLD screening. The start age of 50 years was adopted as the base case of NAFLD screening to allow the potential demonstrable benefits of screening and a corresponding intensive weight reduction programme to take effect. We subsequently calculated the incremental costs, QALY gained, and the ICER of the various screening strategies as compared to no screening. A Tornado analysis was performed to identify the 3 most influential variables within the model. To determine the optimal price threshold of NAFLD treatment for NAFLD screening to remain cost-effective in Singapore, we performed a threshold analysis based on a pre-defined WTP threshold. We then performed a sensitivity analysis to determine the minimal duration of sustainable treatment effect for NAFLD screening to be cost-effective. A sensitivity analysis was also performed for the start age of screening to determine the optimal start age for NAFLD screening. Probabilistic

sensitivity analysis was performed to examine the effects of all parameter uncertainties using 10,000 sets of Monte Carlo simulations. A triangular distribution was applied by using the point estimate, minimal and maximal values as inputs. All analyses were performed using TreeAge Pro 2021 (TreeAge Software Inc, Williamstown, US).

**Model assumptions**

The assumptions adopted in this Markov model are the following. First, we assumed fibrosis regression is not possible in decompensated NASH cirrhosis. Second, we considered the additional unnecessary expenditure brought about by NAFLD screening, assuming that patients with a false positive diagnosis of NAFLD will incur an additional 1-year cost, which is equivalent to their prior fibrosis staging. Third, we assumed the annual rate of fibrosis progression to be constant, including subjects who experienced non-fatal cardiovascular complications. This assumption was made based on a recent study showing that most cardiovascular complications in NAFLD were non-fatal, and the risk of all-cause mortality was similar in NAFLD patients with or without cardiovascular complications.<sup>27</sup> We also assumed the direct medical cost derived from decompensated cirrhosis, HCC and liver transplantation to be similar, irrespective of the underlying aetiology of cirrhosis. Finally, we assumed the screening benefit of fibrosis regression and cardiovascular complications to cease after 5 years.

**RESULTS**

**Base-case analysis**

Base-case analysis of screening at age 50 years demonstrated that both VCTE and FIB-4 screenings were cost-effective, at USD24,727.23/QALY and USD36,799.87/

Table 1. Results of base-case analysis among 5 screening strategies: screening using FIB-4 or VCTE were considered cost-effective with ICER within the willingness to pay threshold (USD50,000)

Strategy	Cost (USD)	Effectiveness (QALY)	Incremental cost (USD)	Incremental effect (QALY)	ICER (USD/QALY)	Label
No screening	20,610.72	11.91	-	-	-	undominated
FIB-4 screening	22,957.79	11.97	2,347.07	0.0638	36,799.87	extendedly dominated
FIB-4+VCTE simultaneous screening	23,401.46	11.98	443.68	0.00692	64,102.01	extendedly dominated
VCTE screening	23,453.16	12.03	2,842.45	0.115	24,727.23	undominated
FIB-4+VCTE Sequential screening	28,735.91	11.98	5,282.75	-0.0461	-114,623.44	absolutely dominated

FIB-4: fibrosis-4; ICER: incremental cost-effectiveness ratio; QALY: quality-adjusted life year; VCTE: vibration-controlled transient elastography



QALY, respectively (Table 1). Meanwhile, screening that adopted either sequential or simultaneous testing (FIB-4 or VCTE) was considered not cost-effective in Singapore.

### One-way sensitivity analysis

Based on one-way sensitivity analysis, the 3 most influential variables in the screening model were the duration of screening benefit, the effectiveness of NAFLD treatment in fibrosis regression within the first 5 years of screening, and the utility of no to mild fibrosis (F0–F1) health states (Fig. 2). For VCTE screening to be cost-effective, the minimum duration of screening benefit should be at least 2.69 years. Similarly, the minimum duration of screening benefit should be at least 3.86 years for FIB-4 screening to be cost-effective (Fig. 3). The screening benefit remains when sensitivity analysis was performed on ages 50 to 70 years, with most benefits observed when screening was started at the age of 50 (Fig. 4).

Based on multivariate probability sensitivity analysis performed in 10,000 Monte Carlo simulations, NAFLD

screening using VCTE or FIB-4, was cost-effective 90.7% and 73.2% of the time, respectively (Fig. 5). The cost-effective acceptability curve showed that NAFLD screening using either VCTE or FIB-4 was cost-effective when a WTP of USD50,000 was considered. Finally, price threshold analysis showed that for NAFLD screening to be cost-effective, the annual cost of NAFLD treatment should be less than USD751/annum.

### Budget impact analysis

For the budget impact analysis, a total of 10,000 patients for this cohort was assumed (estimated for patients aged 50 years with diabetes for 2019). The current budget impact for the no-screening strategy would be approximately USD206.1 million when patients are tracked over the next 50 years. The budget impact of all patients who underwent a once-off VCTE or FIB-4 screening was USD234.5 million and USD229.6 million, respectively. Given that VCTE is not currently available in the primary care setting, the estimated budget to set up VCTE in all 23 polyclinics throughout Singapore would be approximately USD4.70 million.

### DISCUSSION

NAFLD is a rapidly growing global pandemic. It is expected to be the driving cause of chronic liver disease, cirrhosis, HCC and liver transplantation in the near future.<sup>28</sup> Identifying NAFLD patients at greater risk of cirrhosis progression and death is important for early intervention. Despite an increased prevalence of NAFLD among high-risk populations such as T2DM, current guidelines were conflicting when recommending population-based NAFLD screening.<sup>9,10</sup> In this study, we found that NAFLD screening is cost-effective among T2DM patients. For NAFLD screening to be considered cost-effective in Singapore, the benefits of treatment should last at least 2.6 years, and the cost of treatment should be less than USD751 per annum. To our best knowledge, this is the first study evaluating the cost-effectiveness of NAFLD screening among T2DM patients in Singapore. As there is no structured NAFLD screening programme in Singapore,<sup>10</sup> our findings are important to inform policymakers on the cost-effectiveness of NAFLD screening to curb the upcoming “obesity tsunami”. With multiple novel NAFLD treatments in the pipeline, the price threshold analysis will be relevant globally when considering the price of NAFLD treatments when they are eventually available.<sup>29</sup>

Our study found that NAFLD screening among high-risk populations such as T2DM patients is cost-effective when using either VCTE or FIB-4 alone. It is

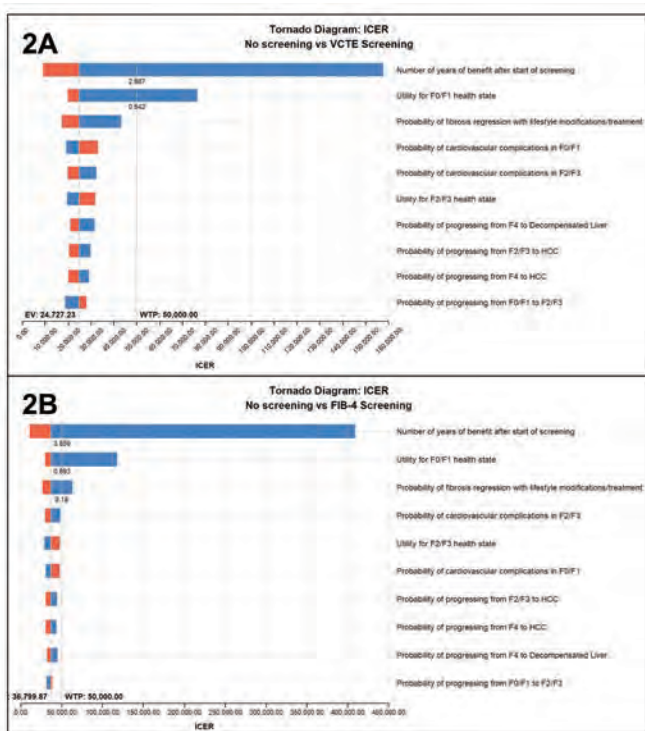

Fig. 2. Tornado diagram of base-case analysis. This model illustrates the result of one-way sensitivity analyses performed to study the effects of altering uncertainty parameters within the minimum-maximum ranges, including all clinical effects, costs and utilities on the incremental cost-effectiveness ratio in the model for (A) vibration-controlled transient elastography, and (B) fibrosis-4. FIB-4: fibrosis-4; HCC: hepatocellular carcinoma; ICER: incremental cost-effectiveness ratio; VCTE: vibration-controlled transient elastography; WTP: willingness to pay

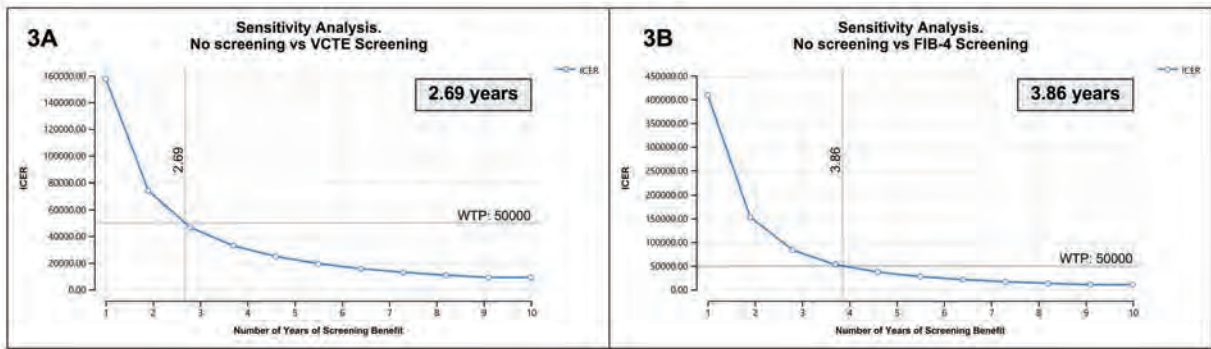

Fig. 3. Minimum duration of screening benefit for (A) vibration-controlled transient elastography and (B) fibrosis-4 to be cost-effective. FIB-4: fibrosis-4; ICER: incremental cost-effectiveness ratio; VCTE: vibration-controlled transient elastography; WTP: willingness to pay

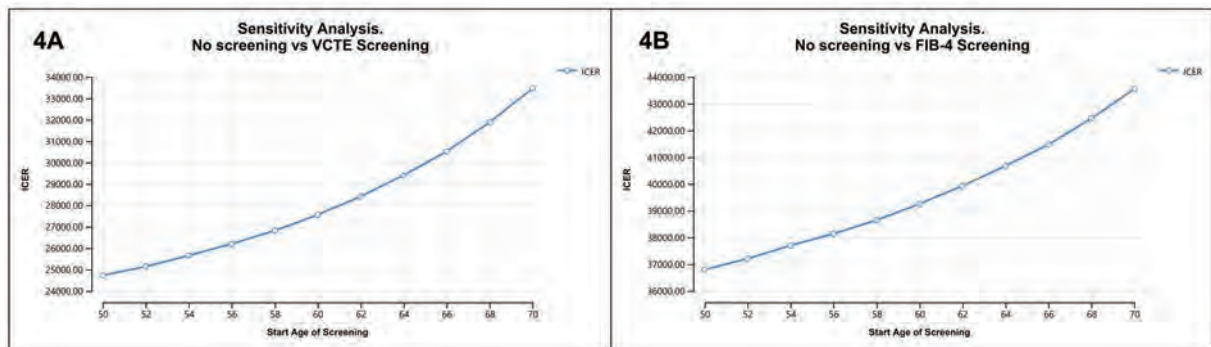

Fig. 4. One-way sensitivity analysis performed to study the effects of start age of screening for (A) vibration-controlled transient elastography and (B) fibrosis-4 to be cost-effective. FIB-4: fibrosis-4; ICER: incremental cost-effectiveness ratio; VCTE: vibration-controlled transient elastography

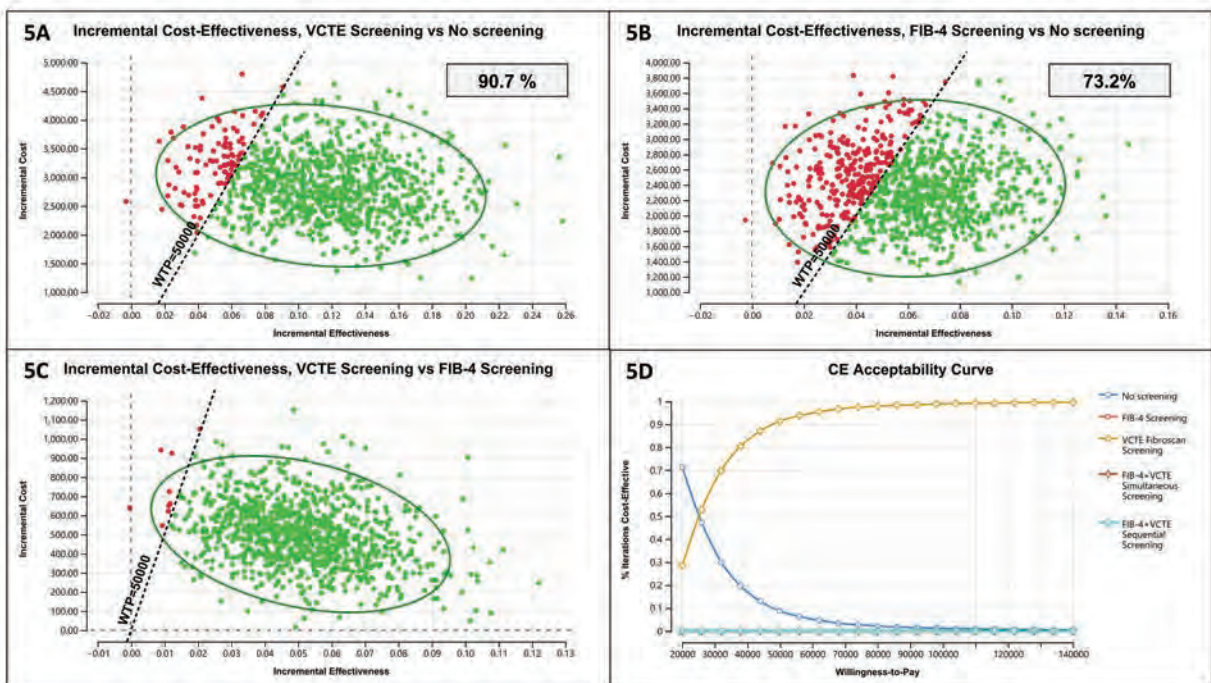

Fig. 5. Multivariate probabilistic sensitivity analysis, based on 10,000 Monte Carlo simulations. (A) Incremental cost-effectiveness scatterplot comparing vibration-controlled transient elastography (VCTE) screening versus no screening. (B) Incremental cost-effectiveness scatterplot comparing fibrosis-4 (FIB-4) screening versus no screening. (C) Incremental cost-effectiveness scatterplot comparing VCTE screening versus FIB-4 screening. (D) Cost-effectiveness acceptability curve. CE: cost-effectiveness; FIB-4: fibrosis-4; ICER: incremental cost-effectiveness ratio; VCTE: vibration-controlled transient elastography



believed that the superiority of VCTE over FIB-4 was driven by VCTE's better accuracy in detecting NAFLD with advanced fibrosis, thus allowing more high-risk patients to receive early therapeutic intervention.<sup>7</sup> However, the adoption of VCTE as the primary modality for population-based NAFLD screening should take into consideration the availability of VCTE machines and trained technicians, as the interpretation of VCTE is currently not available at the community level. Meanwhile, although FIB-4 is an extendedly dominated strategy (i.e. having a higher ICER yet less effective than VCTE) when compared with VCTE screening, it is also a cost-effective strategy within the WTP threshold when compared with no screening. Through our budget impact analysis, we demonstrated the significant cost and burden of NAFLD in our setting. The impact of the budget for both VCTE and FIB-4 was also included to provide policymakers with estimates for financial budgeting. Hence, FIB-4 can be considered in situations where the financial budget to set up the VCTE in the primary care setting is a constraint.

The high prevalence of T2DM observed in the SingHealth Diabetes Registry was consistent with other Asian studies.<sup>30</sup> While our model described a once-off screening strategy, repeated screening may be considered in 3–5 years' time, given that 50% of T2DM patients developed NAFLD in 3 years, even though few experienced fibrosis progressions within 3 years.<sup>31</sup>

Another important finding in our study is that the duration of screening benefit was identified as one of the key determinants in determining cost-effectiveness. While it is logical to expect screening benefits to gradually taper off with time, this was not considered in prior cost-effectiveness studies.<sup>21,22</sup> We found that the benefits of screening should last at least 2.6 and 3.8 years for VCTE and FIB-4, respectively, for screening to remain cost-effective. It was also useful for determining the target population of interest, in which the screening benefit will be limited for patients with an expected life expectancy of less than 4 years from the point of NAFLD screening. Furthermore, the consideration of treatment pricing thresholds was crucial in the recommended treatment cost of USD751 per annum for cost-effectiveness to be maintained within the currently adopted WTP thresholds. These important considerations on the model structure and study design are useful and potentially transferable for future cost-effectiveness analysis on population-based NAFLD screening.

This study has several strengths. First, clinical data were derived from the SingHealth Diabetes Registry, comprising 208,102 individuals from 8 sites within SingHealth, the largest healthcare cluster in Singapore.<sup>12</sup> Second, due to increasing evidence available in the field of NAFLD research, we were able to incorporate NAFLD-specific cost and utility, as well as cardiovascular-related outcomes<sup>17,26</sup> in our model. We model the impact of cardiovascular-related complications—the main cause of mortality in NAFLD patients.<sup>32</sup> Third, to provide a more conservative estimate, our model also accounted for the duration of sustainable screening benefit for the findings to be rendered cost-effective. Fourth, the current strategies compared in our model is also in line with the latest recommendations from the American Association of Endocrinology Clinical Practice Guideline for the diagnosis and management of NAFLD in primary care and endocrinology in the clinical setting.<sup>33</sup> Finally, our price threshold analysis also provided a cost benchmark for NAFLD treatment, where NAFLD screening will remain cost-effective, as future NAFLD treatments become available.

We acknowledge that there are limitations to this study. First, even though VCTE is the most cost-effective strategy for NAFLD screening, the additional budget required to set up VCTE in the primary care setting was not included in this study. Meanwhile, FIB-4 as the alternative cost-effective option is more readily available, implementable, and scalable in the primary care setting. Second, the benefits of NAFLD treatment were assumed to be consistent in this study. To provide a more realistic and conservative estimate, we assumed the benefits of NAFLD treatment to last up to 5 years to avoid over-estimating the screening benefit. Third, we acknowledged the limitations on the performance of non-invasive markers selected in our model. For example, FIB-4 can be influenced by age, with decreasing accuracy beyond 70 years old.<sup>34</sup> Our model did not consider other serum-based biomarkers such as Enhanced Liver Fibrosis Test, FibroTest, Hepascore or PRO-C3 as they were not readily available in the local context. We also did not consider magnetic resonance imaging elastography for NAFLD screening given its long wait time and limited availability even in tertiary care, making it impractical as a population-based screening tool. The impact of NAFLD screening on non-hepatic cancers was not included in our model due to heterogeneity and wide ranges of prevalence and treatment costs of various cancers. We acknowledge that a structured programme may be required to ensure the continued adoption of lifestyle modifications in

NAFLD patients, which may increase the cost of the NAFLD screening programme. Because of differences in the healthcare system, decision-making criteria, and cost data, we acknowledge that our cost-effectiveness findings may not be directly extrapolated to other countries. Nevertheless, important considerations in the model structure (minimal duration of sustained screening benefit and cardiovascular-related complications) and study design (price threshold analysis) are useful factors that can be adapted for future cost-effectiveness analysis on population-based NAFLD screening. Finally, artificial intelligence and machine learning may present a new frontier for identifying NAFLD patients at high risk for fibrosis progression or liver-related complications.

In summary, NAFLD screening among T2DM patients is a cost-effective approach to reducing the disease burden of NAFLD in Singapore. Our findings complement our current understanding of NAFLD screening by estimating the minimal duration of screening benefit and incorporating cardiovascular outcomes into the existing NAFLD model. With an expanding treatment armamentarium for NAFLD, our findings are timely in providing a cost-effective threshold for NAFLD treatment in the setting of population-based NAFLD screening.

#### Funding

*Dr YJ Wong is supported by the Nurturing Clinician Scientist Scheme award by SingHealth Duke-NUS Academic Medical Centre.*

#### REFERENCES

- Chen K, Sng WK, Quah JH, et al. Clinical spectrum of non-alcoholic fatty liver disease in patients with diabetes mellitus. *PLoS ONE* 2020;15:e0236977.
- Estes C, Chan HLY, Chien RN, et al. Modelling NAFLD disease burden in four Asian regions-2019-2030. *Aliment Pharmacol Ther* 2020;51:801-11.
- Dulai PS, Singh S, Patel J, et al. Increased risk of mortality by fibrosis stage in nonalcoholic fatty liver disease: Systematic review and meta-analysis. *Hepatology* 2017;65:1557-65.
- White DL, Kanwal F, El-Serag HB. Association Between Nonalcoholic Fatty Liver Disease and Risk for Hepatocellular Cancer, Based on Systematic Review. *Clin Gastroenterol Hepatol* 2012;10:1342-59.e2.
- Zhou YJ, Gao F, Liu WY, et al. Screening for compensated advanced chronic liver disease using refined Baveno VI elastography cutoffs in Asian patients with nonalcoholic fatty liver disease. *Aliment Pharmacol Ther* 2021;54:470-80.
- Vilar-Gomez E, Martinez-Perez Y, Calzadilla-Bertot L, et al. Weight Loss Through Lifestyle Modification Significantly Reduces Features of Nonalcoholic Steatohepatitis. *Gastroenterology* 2015;149:367-78.e5; quiz e14-5.
- Chan WK, Treeprasertsuk S, Goh GB, et al. Optimizing Use of Nonalcoholic Fatty Liver Disease Fibrosis Score, Fibrosis-4 Score, and Liver Stiffness Measurement to Identify Patients With Advanced Fibrosis. *Clin Gastroenterol Hepatol* 2019;17:2570-80.e37.
- Chalasanani N, Younossi Z, Lavine JE, et al. The diagnosis and management of nonalcoholic fatty liver disease: Practice guidance from the American Association for the Study of Liver Diseases. *Hepatology* 2018;67:328-57.
- Eslam M, Sarin SK, Wong VW, et al. The Asian Pacific Association for the Study of the Liver clinical practice guidelines for the diagnosis and management of metabolic associated fatty liver disease. *Hepatol Int* 2020;14:889-919.
- Blond E, Disse E, Cuerq C, et al. EASL-EASD-EASO Clinical Practice Guidelines for the management of non-alcoholic fatty liver disease. *J Hepatol* 2016;64:1388-402.
- Zhang X, Wong GL, Yip TC, et al. Risk of liver-related events by age and diabetes duration in patients with diabetes and nonalcoholic fatty liver disease. *Hepatology* 2022;76:1409-22.
- Lim DYZ, Chia SY, Abdul Kadir H, et al. Establishment of the SingHealth Diabetes Registry. *Clin Epidemiol* 2021;13:215-23.
- Li J, Zou B, Yeo YH, et al. Prevalence, incidence, and outcome of non-alcoholic fatty liver disease in Asia, 1999-2019: a systematic review and meta-analysis. *Lancet Gastroenterol Hepatol* 2019;4:389-98.
- Chin CT, Mellstrom C, Chua TS, et al. Lifetime cost-effectiveness analysis of ticagrelor in patients with acute coronary syndromes based on the PLATO trial: a Singapore healthcare perspective. *Singapore Med J* 2013;54:169-75.
- Sanyal AJ, Banas C, Sargeant C, et al. Similarities and differences in outcomes of cirrhosis due to nonalcoholic steatohepatitis and hepatitis C. *Hepatology* 2006;43:682-9.
- Ascha MS, Hanouneh IA, Lopez R, et al. The incidence and risk factors of hepatocellular carcinoma in patients with nonalcoholic steatohepatitis. *Hepatology* 2010;51:1972-8.
- Baratta F, Pastori D, Angelico F, et al. Nonalcoholic Fatty Liver Disease and Fibrosis Associated With Increased Risk of Cardiovascular Events in a Prospective Study. *Clin Gastroenterol Hepatol* 2020;18:2324-31.e4.
- Ito T, Ishigami M, Ishizu Y, et al. Utility and limitations of noninvasive fibrosis markers for predicting prognosis in biopsy-proven Japanese non-alcoholic fatty liver disease patients. *J Gastroenterol Hepatol* 2019;34:207-14.
- Yang X, Chang X, Wu S, et al. Performance of liver stiffness measurements obtained with FibroScan is affected by glucose metabolism in patients with nonalcoholic fatty liver disease. *Lipids Health Dis* 2021;20:27.
- Eddowes PJ, Sasso M, Allison M, et al. Accuracy of FibroScan Controlled Attenuation Parameter and Liver Stiffness Measurement in Assessing Steatosis and Fibrosis in Patients With Nonalcoholic Fatty Liver Disease. *Gastroenterology* 2019;156:1717-30.
- Phisalprapa P, Supakankunti S, Charatcharoenwitthaya P, et al. Cost-effectiveness analysis of ultrasonography screening for nonalcoholic fatty liver disease in metabolic syndrome patients. *Medicine (Baltimore)* 2017;96:e6585.
- Noureddin M, Jones C, Alkhoury N, et al. Screening for Nonalcoholic Fatty Liver Disease in Persons with Type 2 Diabetes in the United States Is Cost-effective: A Comprehensive Cost-Utility Analysis. *Gastroenterology* 2020;159:1985-87.e4.



23. Hui JM, Kench JG, Chitturi S, et al. Long-term outcomes of cirrhosis in nonalcoholic steatohepatitis compared with hepatitis C. *Hepatology* 2003;38:420-7.
24. Yatsuji S, Hashimoto E, Tobari M, et al. Clinical features and outcomes of cirrhosis due to non-alcoholic steatohepatitis compared with cirrhosis caused by chronic hepatitis C. *J Gastroenterol Hepatol* 2009;24:248-54.
25. Sanyal AJ, Anstee QM, Trauner M, et al. Cirrhosis regression is associated with improved clinical outcomes in patients with nonalcoholic steatohepatitis. *Hepatology* 2022;75:1235-46.
26. Sanyal AJ, Van Natta ML, Clark J, et al. Prospective Study of Outcomes in Adults with Nonalcoholic Fatty Liver Disease. *N Engl J Med* 2021;385:1559-69.
27. Shang Y, Nasr P, Widman L, et al. Risk of cardiovascular disease and loss in life expectancy in non-alcoholic fatty liver disease. *Hepatology* 2022;76:1495-505.
28. Burra P, Becchetti C, Germani G. NAFLD and liver transplantation: Disease burden, current management and future challenges. *JHEP Rep* 2020;2:100192.
29. Majzoub AM, Nayfeh T, Barnard A, et al. Systematic review and network meta-analysis: comparative efficacy of pharmacologic therapies for fibrosis improvement and resolution of NASH. *Aliment Pharmacol Ther* 2021;54:880-9.
30. Kwok R, Choi KC, Wong GL, et al. Screening diabetic patients for non-alcoholic fatty liver disease with controlled attenuation parameter and liver stiffness measurements: a prospective cohort study. *Gut* 2016;65:1359-68.
31. Lee HW, Wong GL, Kwok R, et al. Serial Transient Elastography Examinations to Monitor Patients With Type 2 Diabetes: A Prospective Cohort Study. *Hepatology* 2020;72:1230-41.
32. Johansen P, Howard D, Bishop R, et al. Systematic Literature Review and Critical Appraisal of Health Economic Models Used in Cost-Effectiveness Analyses in Non-Alcoholic Steatohepatitis: Potential for Improvements. *Pharmacoeconomics* 2020;38:485-97.
33. Cusi K, Isaacs S, Barb D, et al. American Association of Clinical Endocrinology Clinical Practice Guideline for the Diagnosis and Management of Nonalcoholic Fatty Liver Disease in Primary Care and Endocrinology Clinical Settings: Co-Sponsored by the American Association for the Study of Liver Diseases (AASLD). *Endocr Pract* 2022;28:528-62.
34. McPherson S, Hardy T, Dufour JF, et al. Age as a Confounding Factor for the Accurate Non-Invasive Diagnosis of Advanced NAFLD Fibrosis. *Am J Gastroenterol* 2017;112:740-51.
35. Dan YY, Ferrante SA, Elbasha EH, et al. Cost-Effectiveness of Boceprevir Co-Administration versus Pegylated Interferon- $\alpha$ 2b and Ribavirin Only for Patients with Hepatitis C Genotype 1 in Singapore. *Antivir Ther* 2015;20:209-16.
36. Harrison SA, Torgerson S, Hayashi PH. The natural history of nonalcoholic fatty liver disease: a clinical histopathological study. *Am J Gastroenterol* 2003;98:2042-7.
37. Adams LA, Sanderson S, Lindor KD, et al. The histological course of nonalcoholic fatty liver disease: a longitudinal study of 103 patients with sequential liver biopsies. *J Hepatol* 2005;42:132-8.
38. Starley BQ, Calcagno CJ, Harrison SA. Nonalcoholic fatty liver disease and hepatocellular carcinoma: A weighty connection. *Hepatology* 2010;51:1820-32.
39. Lassailly G, Caiazzo R, Buob D, et al. Bariatric Surgery Reduces Features of Nonalcoholic Steatohepatitis in Morbidly Obese Patients. *Gastroenterology* 2015;149:379-88; quiz e15-6.
40. Kyu HH, Bachman VF, Alexander LT, et al. Physical activity and risk of breast cancer, colon cancer, diabetes, ischemic heart disease, and ischemic stroke events: systematic review and dose-response meta-analysis for the Global Burden of Disease Study 2013. *BMJ* 2016;354:i3857.
41. Shim YT, Lee J, Toh MP, et al. Health-related quality of life and glycaemic control in patients with Type 2 diabetes mellitus in Singapore. *Diabet Med* 2012;29:e241-8.

## National surgical antibiotic prophylaxis guideline in Singapore

Wei Teng Gladys Chung<sup>1</sup>*MClinPharm*, Humaira Shafi<sup>2</sup>*MD*, Jonathan Seah<sup>3</sup>*PharmD*, Parthasarathy Purnima<sup>4</sup>*MBBS*, Taweechai Patun<sup>5</sup>*PharmD*, Kai-Qian Kam<sup>6</sup>*MBBS*, Valerie Xue Fen Seah<sup>7</sup>*PharmD*, Rina Yue Ling Ong<sup>7</sup>*PharmD*, Li Lin<sup>8</sup>*MD*, Robin Sing Meng Choo<sup>9</sup>*MClinPharm*, Pushpalatha Lingegowda<sup>10</sup>*MD*, Cheryl Li Ling Lim<sup>11</sup>*MSc (InfectDis)*, Jasmine Shimin Chung<sup>12</sup>*FRCPEdin*, Nathalie Grace SY Chua<sup>13</sup>*PharmD*, Tau Hong Lee<sup>14</sup>*MBBS*, Min Yi Yap<sup>15</sup>*MClinPharm*, Tat Ming Ng<sup>15</sup>*PharmD*, Jyoti Somani<sup>16</sup>*MD*

### ABSTRACT

**Introduction:** Institutional surgical antibiotic prophylaxis (SAP) guidelines are in place at all public hospitals in Singapore, but variations exist and adherence to guidelines is not tracked consistently. A national point prevalence survey carried out in 2020 showed that about 60% of surgical prophylactic antibiotics were administered for more than 24 hours. This guideline aims to align best practices nationally and provides a framework for audit and surveillance.

**Method:** This guideline was developed by the National Antimicrobial Stewardship Expert Panel's National Surgical Antibiotic Prophylaxis Guideline Development Workgroup Panel, which comprises infectious diseases physicians, pharmacists, surgeons and anaesthesiologists. The Workgroup adopted the ADAPTE methodology framework with modifications for the development of the guideline. The recommended duration of antibiotic prophylaxis was graded according to the strength of consolidated evidence based on the scoring system of the Singapore Ministry of Health Clinical Practice Guidelines.

**Results:** This National SAP Guideline provides evidence-based recommendations for the rational use of antibiotic prophylaxis. These include recommended agents, dose, timing and duration for patients undergoing common surgeries based on surgical disciplines. The Workgroup also provides antibiotic recommendations for special patient population groups (such as patients with  $\beta$ -lactam allergy and patients colonised with methicillin-resistant *Staphylococcus aureus*), as well as for monitoring and surveillance of SAP.

**Conclusion:** This evidence-based National SAP Guideline for hospitals in Singapore aims to align practices and optimise the use of antibiotics for surgical prophylaxis for the prevention of surgical site infections while reducing adverse events from prolonged durations of SAP.

Ann Acad Med Singap 2022;51:695-711

**Keywords:** Antibiotic prophylaxis duration, antimicrobial resistance, antimicrobial stewardship, hospital-acquired infection, surgical site infections

<sup>1</sup> Pharmacy Department, National University Hospital, Singapore

<sup>2</sup> Department of Infectious Diseases, Changi General Hospital, Singapore

<sup>3</sup> Department of Pharmacy, Changi General Hospital, Singapore

<sup>4</sup> Division of Infectious Diseases, Department of General Medicine, Khoo Teck Puat Hospital, Singapore

<sup>5</sup> Department of Pharmacy, Khoo Teck Puat Hospital, Singapore

<sup>6</sup> Infectious Disease Service, Department of Paediatrics, KK Women's and Children's Hospital, Singapore

<sup>7</sup> Department of Pharmacy, KK Women's and Children's Hospital, Singapore

<sup>8</sup> Division of Infectious Diseases, Department of Medicine, Ng Teng Fong General Hospital, Singapore

<sup>9</sup> Department of Pharmacy, Ng Teng Fong General Hospital, Singapore

<sup>10</sup> Department of General Medicine, Sengkang General Hospital, Singapore

<sup>11</sup> Pharmacy Department, Sengkang General Hospital, Singapore

<sup>12</sup> Department of Infectious Diseases, Singapore General Hospital, Singapore

<sup>13</sup> Department of Pharmacy, Singapore General Hospital, Singapore

<sup>14</sup> Department of Infectious Diseases, Tan Tock Seng Hospital, Singapore

<sup>15</sup> Division of Pharmacy, Tan Tock Seng Hospital, Singapore

<sup>16</sup> Division of Infectious Diseases, Department of Medicine, National University Hospital, Singapore

Correspondence: Ms Wei Teng Gladys Chung, Pharmacy Department, National University Hospital, 5 Lower Kent Ridge Road, Singapore 119074.

Email: [wei\\_teng\\_chung@nuhs.edu.sg](mailto:wei_teng_chung@nuhs.edu.sg)

This article was first published online on 18 November 2022 at [annals.edu.sg](https://annals.edu.sg)

## CLINICAL IMPACT

### What is New

- This is the first surgical antibiotic prophylaxis (SAP) guideline in Singapore that provides evidence-based recommendations for the antibiotic choice, dose, timing and duration for adult patients undergoing elective clean or clean-contaminated surgeries.
- It highlights the evidence that prolonged SAP duration has no benefit, and may be associated with harm.

### Clinical Implications

- This guideline aims to align practices and optimise the use of SAP for the prevention of surgical site infections, while also reducing adverse events from prolonged durations of SAP.

## INTRODUCTION

Surgical antibiotic prophylaxis (SAP) refers to the administration of antibiotics prior to clean and clean-contaminated surgeries to prevent postoperative surgical site infections (SSIs). An optimal SAP should be highly effective in preventing SSI. An ideal prophylactic antibiotic regimen is: (1) effective against pathogens—generally skin flora—most likely to contaminate the surgical site; (2) appropriately dosed, and timed so that the highest tissue concentration is present upon skin incision; (3) safe; and (4) administered for the shortest effective period to minimise adverse effects, the development of antimicrobial resistance, and costs.<sup>1</sup> Antibiotics should also be re-dosed if surgery is prolonged or there is significant blood loss, to ensure adequate serum and tissue concentrations throughout the entire procedure.

Institutional SAP guidelines are in place at all public hospitals in Singapore but variations exist, and adherence to these guidelines is not reported nationally. Point prevalence surveys on antimicrobial utilisation conducted by Singapore public hospitals in 2020 showed that the prophylactic use of antibiotics for surgeries accounted for 10% of all antimicrobial agents prescribed, and about 60% of these prophylactic antibiotics were administered for more than 24 hours.<sup>2</sup> This is particularly concerning as various international guidelines state that SAP should be discontinued after skin closure following most procedures. These are

strong recommendations based on moderate- to high-quality clinical evidence.<sup>1,3,4</sup> Current evidence shows that SAP has no benefit when given beyond 24 hours, and may be associated with harm such as an increased risk of acute kidney injury and *Clostridioides difficile* infections.<sup>5-7</sup> Moreover, unnecessarily long durations of SAP do not prevent wound infections, but in fact, may increase the risk of infections with multidrug-resistant organisms due to antibiotic selection pressure.<sup>8</sup>

Appropriate SAP should be regarded as one of the components of an effective policy for the control of healthcare-associated infection (HAI), and also an important aspect of quality, patient safety, and antibiotic stewardship in the hospital. Based on the first national point prevalence survey conducted in public hospitals in Singapore, SSI was the second most common HAI after pneumonia, accounting for 17.3% of HAI.<sup>9</sup> The establishment of the National SAP Guideline for hospitals in Singapore may reduce the rate of SSI by improving the choice and timing of SAP, while also reducing adverse events from prolonged courses of SAP, thereby promoting patient safety and addressing the problem of antimicrobial resistance.<sup>8</sup>

Thus, the National SAP Guideline provides evidence-based recommendations for the rational use of antibiotic prophylaxis. These include recommended agent(s), dose, timing and duration for patients undergoing more common surgical procedures. This guideline aims to align national best practices and provide a framework for audit and surveillance. The National Antimicrobial Stewardship Expert Panel (NASEP) envisions that this guideline would be an impetus for all institutions to improve the use of SAP for the benefit of patient care and quality.

## METHOD

This guideline was developed by the NASEP's National Surgical Antibiotic Prophylaxis Guideline Development Workgroup Panel. The workgroup was led by 2 co-chairs and comprised infectious diseases physicians, infectious diseases and/or antimicrobial stewardship-trained pharmacists, surgeons and anaesthesiologists. The workgroup was divided into subgroups of 9 main surgical disciplines, and literature search was performed and presented by the individual subgroups.

The Workgroup Panel adopted the ADAPTE methodology framework<sup>10</sup> with modifications in the development of the guideline. Members of the Workgroup Panel aimed to ensure the validity, reliability and applicability of the guideline for the Singapore setting. The primary literature published

in the English language through December 2020 was identified by searches of PubMed and the Cochrane Database of Systematic Reviews. Studies from the literature search, together with published international guidelines—such as the American Society of Health-System Pharmacists (ASHP), the Infectious Diseases Society of America (IDSA), the National Institute for Health and Care Excellence (NICE), and the US Centers for Disease Control and Prevention (CDC)—were reviewed in detail. Particular attention was paid to the study design, with the greatest credence given to systematic reviews, meta-analyses and randomised controlled double-blinded studies.

The recommended duration of antibiotic prophylaxis was graded according to the strength of consolidated evidence-based on the scoring system of the Singapore Ministry of Health (MOH) Clinical Practice Guidelines

(Tables 1 and 2). For procedures in which antibiotic prophylaxis is not recommended, the strength of evidence represents the support against prophylaxis. The description of the evidence base can be found in the online Supplementary Appendix 1.

The draft documents for each surgical procedure were collated and edited by the co-chairpersons before being circulated and reviewed by the Workgroup. The completed guideline was formally submitted for review and endorsement by the MOH National Antimicrobial Resistance Control Committee (NARCC) and National Centre for Infectious Diseases (NCID), together with Chapter of Infectious Disease Physicians, College of Anaesthesiologists, and College of Surgeons of the Academy of Medicine, Singapore. Medical practitioners from the private hospitals were also formally engaged for comments. The Workgroup had 6 rounds of

Table 1. Levels of evidence

Level	Type of evidence
1 <sup>++</sup>	High-quality meta-analyses, systematic reviews of randomised controlled trials (RCTs), or RCTs with a very low risk of bias
1 <sup>+</sup>	Well-conducted meta-analyses, systematic reviews of RCTs, or RCTs with a low risk of bias
1 <sup>-</sup>	Meta-analyses, systematic reviews of RCTs, or RCTs with a high risk of bias
2 <sup>++</sup>	High-quality systematic reviews of case control or cohort studies. High-quality case-control or cohort studies with a very low risk of confounding or bias and a high probability that the relationship is causal
2 <sup>+</sup>	Well-conducted case control or cohort studies with a low risk of confounding or bias and a moderate probability that the relationship is causal
2 <sup>-</sup>	Case control or cohort studies with a high risk of confounding or bias and a significant risk that the relationship is not causal
3	Non-analytic studies, e.g. case reports and case series
4	Expert opinion

Table 2. Grades of recommendation

Grade	Recommendation
A	At least one meta-analysis, systematic review of RCTs, or RCT rated as 1 <sup>++</sup> and directly applicable to the target population; or A body of evidence consisting principally of studies rated as 1 <sup>+</sup> , directly applicable to the target population, and demonstrating overall consistency of results
B	A body of evidence including studies rated as 2 <sup>++</sup> , directly applicable to the target population, and demonstrating overall consistency of results; or Extrapolated evidence from studies rated as 1 <sup>++</sup> or 1 <sup>+</sup>
C	A body of evidence including studies rated as 2 <sup>+</sup> , directly applicable to the target population and demonstrating overall consistency of results; or Extrapolated evidence from studies rated as 2 <sup>++</sup>
D	Evidence level 3 or 4; or Extrapolated evidence from studies rated as 2 <sup>+</sup>
GPP (good practice points)	Recommended best practice based on the clinical experience of the guideline development group



virtual meetings from December 2020 to April 2022 to discuss the comments and make modifications to the guideline (Fig. 1).

The recommendations in this guideline apply to elective clean and clean-contaminated procedures in the adult population. Clean procedures involve an incision in which no inflammation is encountered, without a break in sterile technique, and during which the respiratory, alimentary or genitourinary tracts are not entered; clean-contaminated procedures involve an incision through which the respiratory, alimentary or genitourinary tract is entered under controlled conditions but with no contamination encountered.<sup>11</sup>

This guideline does not cover the following:

- Treatment of infection in patients undergoing emergency surgery for contaminated or dirty wounds.
- Antibiotic prophylaxis for prevention of infective endocarditis.
- Antibiotic prophylaxis in patients with prosthetic implants undergoing dental surgery or other surgery that may cause bacteraemia.
- Use of antiseptic for prevention of wound infection after elective surgery.
- Administration of topical antibiotics in wounds.

Individual healthcare institutions should consider resistance patterns of organisms and overall SSI rates at

their respective sites when adopting these recommendations. The Workgroup Panel recognises the importance of other non-antimicrobial factors to reduce the risk of SSI, but the discussion of these factors lies outside the scope of this guideline.

This guideline will be of interest to surgeons, infectious diseases physicians, anaesthesiologists, pharmacists, microbiologists, infection control nurses, epidemiologists and public health professionals.

The full guideline is available at <https://www.ncid.sg/Health-Professionals/Pages/Antimicrobial-Resistance.aspx> as a reference to guide practice.

## RESULTS

### *Surgical antibiotic prophylaxis practice points*

SAP with the right antibiotic, dose and timing has been found to be of benefit for most clean-contaminated, as well as in certain clean procedures where there are severe consequences of infection (e.g. placement of prosthesis or implant).<sup>1</sup> SAP may not be required in clean, uncomplicated procedures not involving the placement of prostheses or implants. For contaminated or infected wounds, antibiotic treatment is indicated and not considered as surgical prophylaxis.

### *Antibiotic choice*

Most SSI are caused by skin flora or from flora that may be found at the site of the organ being operated

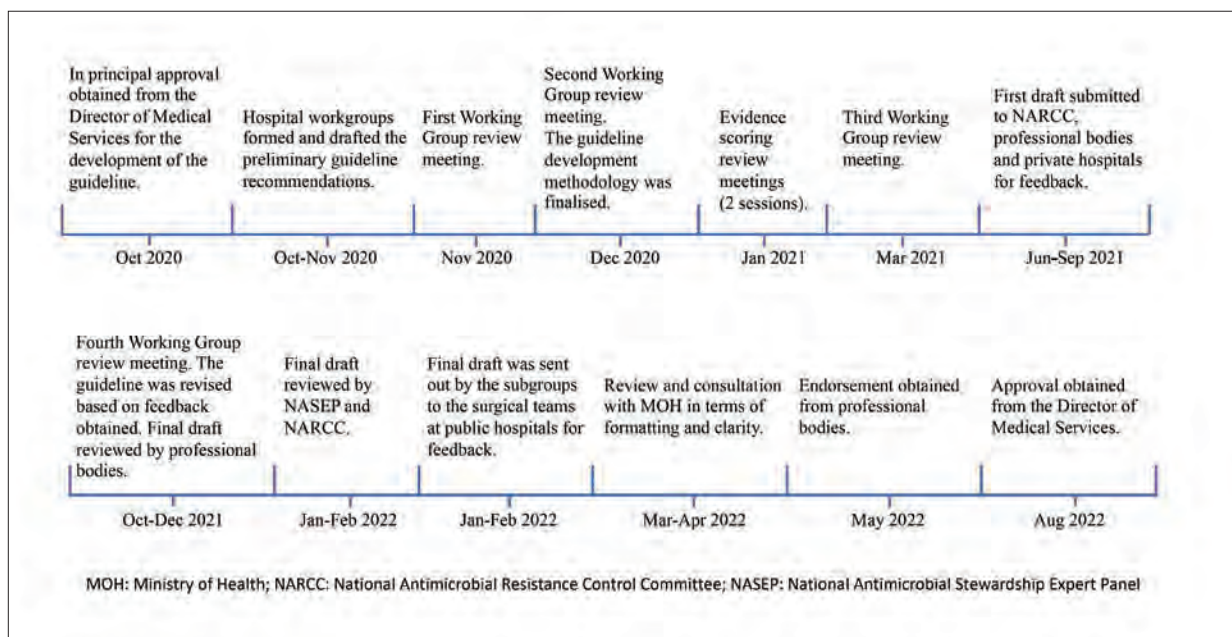

Fig. 1. Timeline of guideline development process highlighting time points at which feedback was solicited and incorporated into guideline development and revision.

on (e.g. Gram-negative and anaerobic bowel flora for surgeries traversing the colon). The antibiotic selected must cover the expected pathogen for the operative site and concentrate in high levels at the site prior to incision. Narrow-spectrum antibiotic agents are preferred. The association of some antibiotic agents (such as third-generation cephalosporins, fluoroquinolones and clindamycin) with the increased risk of *C. difficile* infections, and the development of multidrug-resistant colonisation or infections, should be taken into consideration.<sup>12,13</sup> The choice of antibiotics should also take into account the resistance patterns at their respective sites. The recommended antibiotic prophylaxis for specific surgical procedures, along with alternatives for patients with severe penicillin allergy, is provided in Table 3.

#### **Administration timing**

The ideal antibiotic dose should be given in time to reach and maintain optimal levels in both blood and tissue from the time of incision until the closure of surgical wounds. Therefore, the dose and timing of antibiotic administration are important. The optimal time for administration of most preoperative doses is 30 to 60 minutes before surgical incision. The antibiotic should be infused completely prior to the incision. Specific agents (fluoroquinolones and vancomycin) that require longer infusion time should be administered at least 1 hour before the incision.<sup>1,14,15</sup> Prospective cohort studies specifically in cardiac surgeries have demonstrated that incomplete infusion of preoperative vancomycin was associated with a higher risk for SSI.<sup>16,17</sup> For emergency procedures when vancomycin cannot be infused due to limited time, teicoplanin is an effective option. Teicoplanin may be administered over 3 to 5 minutes or as a 30-minute infusion.<sup>18,19</sup>

#### **Methicillin-resistant *Staphylococcus aureus* (MRSA) risk and antimicrobial coverage**

Screening and selective decolonisation of patients positive for MRSA have been shown to prevent SSI.<sup>20-25</sup> The Workgroup Panel recommends screening and decolonisation for patients who will be undergoing high-risk surgeries (cardiac, orthopaedic and neurosurgery with implant). Decolonisation without screening is not recommended as the widespread use of mupirocin has been shown to promote resistance.<sup>20</sup>

Vancomycin prophylaxis should be considered for patients with known MRSA colonisation or recent MRSA infection. This is recommended for (but not limited to) patients undergoing high-risk surgeries.<sup>1</sup>

As vancomycin is less effective than cefazolin in preventing SSI caused by methicillin-susceptible *Staphylococcus aureus*, the addition of cefazolin to vancomycin should be considered for prophylaxis in MRSA colonised patients.<sup>1</sup> This combination was shown to have lower SSI rates,<sup>26-29</sup> although some studies showed a slightly higher risk of acute kidney injury.<sup>30</sup> The Workgroup Panel recommends the use of this combination in MRSA-colonised patients, who undergo cardiac or orthopaedic (involving implants) procedures.

#### **Antibiotic dosing and re-dosing intervals**

The recommended re-dosing intervals for commonly used antibiotics are provided in Table 4.

For aminoglycosides, once-daily dosing is recommended. Gentamicin dosing regimens have been compared for prophylaxis in colorectal surgery. A single gentamicin dose of 5mg/kg was found to be more effective in SSI prevention than multiple doses of 1.5mg/kg given 8-hourly.<sup>31</sup> A large retrospective cohort study of surgical patients (n=1,590) showed that the use of once-daily gentamicin was safe, with similar nephrotoxicity risk between gentamicin versus control (2.5% vs 1.8%,  $P=0.17$ ).<sup>32</sup>

Intraoperative re-dosing is required when:<sup>1,15,33-36</sup>

- the duration of the procedure exceeds 2 half-lives of the drug, or
- there is excessive intra-operative blood loss (i.e. >1,500mL), or
- there are extensive burns.

Therapeutic drug monitoring for vancomycin and aminoglycosides is not required due to the short duration of prophylaxis. If these antibiotics are continued beyond the recommended duration for surgical prophylaxis, therapeutic drug monitoring should be initiated according to institutional guidelines.

#### **Dosing in obese patients**

Obesity has been linked to an increased risk of SSI.<sup>37,38</sup> These patients may require higher doses to ensure adequate tissue concentrations.

These are the recommended dosing for obese patients:

- For cefazolin, the recommended dose if weight is >120kg is 3g instead of the usual 2g.<sup>1</sup>
- For aminoglycoside use in obese patients (actual body weight is 20% above the ideal body weight), the dose is calculated based on the patient's adjusted body weight:<sup>1,3,39</sup>

Table 3. Recommendations for surgical antibiotic prophylaxis

Types of surgery	First line	Alternative for severe penicillin allergy	Duration	Remarks	Level of evidence (Grade)
<b>Breast surgery</b>					
Breast cancer surgery without oncoplastic/reconstruction surgery	Not recommended For patients with risk factors IV cefazolin 2g	Not recommended For patients with risk factors IV clindamycin 600–900mg or IV vancomycin 15–20mg/kg	Single dose	Risk factors: - Post-neoadjuvant chemotherapy - Immunocompromised individuals	Level 1- (Grade B)
Breast cancer surgery with oncoplastic/reconstruction surgery	IV cefazolin 2g Followed by: 1–2g q8h	IV clindamycin 600–900mg Followed by: 600mg q8h or IV vancomycin 15–20mg/kg Followed by: 15mg/kg q12h	Up to 24 hours		Level 1+ (Grade A)
Breast lump excision biopsy	Not recommended	Not recommended	NA	If prophylactic antibiotic is used, it should not exceed a single dose. Refer to the above choices if prophylactic antibiotic is used	Level 1- (Grade B)
Wire localisation excision biopsy					
<b>Cardiothoracic and vascular surgery</b>					
Cardiac (aortic dissection, CABG, TEVAR, valve repair or replacement, LVAD placement, permanent pacemaker/defibrillator insertion)	IV cefazolin 2g Followed by: 1–2g q8h MRSA colonised IV cefazolin 2g + IV vancomycin 15–20mg/kg Followed by: IV cefazolin 1–2g q8h + IV vancomycin 15mg/kg q12h	IV vancomycin 15–20mg/kg Followed by: 15mg/kg q12h	24–48 hours	IV vancomycin dose of 20mg/kg preoperatively may be preferred to achieve sufficient tissue concentrations at the time of surgery  At the onset of bypass: May consider an additional 1–2g of IV cefazolin via cardiopulmonary bypass circuit	Level 1+ (Grade A)
Thoracic (decortication, lobectomy, thymectomy, VATS)	IV cefazolin 2g MRSA colonised IV vancomycin 15–20mg/kg	IV clindamycin 600–900mg or IV vancomycin 15–20mg/kg	Single dose		Level 1- (Grade B)
Vascular (artery or vein repair, AVF or AVG creation, excision, jump graft, aortic stent graft)	IV cefazolin 2g Followed by: 1–2g q8h MRSA colonised IV vancomycin 15–20mg/kg Followed by: 15mg/kg q12h	IV clindamycin 600–900mg Followed by: 600mg q8h or IV vancomycin 15–20mg/kg Followed by: 15mg/kg q12h	Up to 24 hours		Level 1- (Grade B)
Cardiac or vascular (angioplasty, stent insertion)	Not recommended	Not recommended	NA		Level 3 (Grade D)

Table 3. Recommendations for surgical antibiotic prophylaxis (Cont'd)

Types of surgery	First line	Alternative for severe penicillin allergy	Duration	Remarks	Level of evidence (Grade)
<b>Gastrointestinal surgery</b>					
Appendectomy	IV cefazolin 2g + IV metronidazole 500mg or IV ceftriaxone 2g + IV metronidazole 500mg or IV amoxicillin-clavulanic acid 1.2g	IV gentamicin 5mg/kg + IV metronidazole 500mg or IV gentamicin 5mg/kg + IV clindamycin 600–900mg <sup>c</sup>	Single dose		Level 1+ (Grade A)
Gastroduodenal and oesophageal	IV cefazolin 2g or IV ceftriaxone 2g or IV amoxicillin-clavulanic acid 1.2g	IV gentamicin 5mg/kg +/- IV clindamycin 600–900mg	Single dose		Level 1+ (Grade A)
Small bowel	IV cefazolin 2g + IV metronidazole 500mg or IV ceftriaxone 2g + IV metronidazole 500mg or IV amoxicillin-clavulanic acid 1.2g	IV gentamicin 5mg/kg + IV metronidazole 500mg or IV gentamicin 5mg/kg + IV clindamycin 600–900mg <sup>c</sup>	Single dose		Level 1+ (Grade B)
Colorectal	IV cefazolin 2g + IV metronidazole 500mg or IV ceftriaxone 2g + IV metronidazole 500mg or IV amoxicillin-clavulanic acid 1.2g	IV gentamicin 5mg/kg + IV metronidazole 500mg or IV gentamicin 5mg/kg + IV clindamycin 600–900mg <sup>c</sup>	Single dose		Level 1++ (Grade A)
	To be used in conjunction with mechanical bowel preparation (MBP) (if given): PO neomycin sulfate 1g + PO erythromycin base 1g or PO neomycin sulfate 1g + PO metronidazole 1g		Three doses in conjunction with MBP	To be administered over approximately 10 hours the day before operation (e.g. 1 pm to 11 pm) Need for MBP + PO prophylaxis to be decided by individual institutions	Level 1++ (Grade B)
Hernia repair Hernioplasty (i.e. with mesh placement)	IV cefazolin 2g	IV vancomycin 15mg/kg	Single dose	Recommendations for prophylaxis are mainly derived from studies on inguinal/femoral hernia repairs. Mixed outcomes for other types of hernias and studies were often of poor quality.	Level 1++ (Grade B)
Herniorrhaphy (i.e. no mesh placement)	Not recommended	Not recommended	NA		Level 1++ (Grade A)



Table 3. Recommendations for surgical antibiotic prophylaxis (Cont'd)

Types of surgery	First line	Alternative for severe penicillin allergy	Duration	Remarks	Level of evidence (Grade)
<b>Hepatobiliary surgery</b>					
Biliary tract surgery	IV cefazolin 2g or IV ceftriaxone 2g or IV amoxicillin-clavulanic acid 1.2g	IV clindamycin 600–900mg or IV vancomycin 15–20mg/kg + IV gentamicin 5mg/kg or IV aztreonam 2g	Single dose	It is reasonable to give a single dose of prophylaxis to patient undergoing laparoscopic cholecystectomy although evidence showed that antibiotic is not required for low-risk patients. This is because some of these risk factors cannot be determined prior to surgery.	Level 1+ (Grade A)
Hepatectomy	IV cefazolin 2g Followed by: 1–2g 8h or IV ceftriaxone 2g once	IV clindamycin 600–900mg or IV vancomycin 15–20mg/kg + IV gentamicin 5mg/kg or IV aztreonam 2g	Up to 24 hours	If the procedure is expected to involve the lower gastrointestinal tract, consider adding anaerobic coverage	Level 1+ (Grade A)
<b>Splenectomy or left-sided pancreatic surgery</b>					
Splenectomy or left-sided pancreatic surgery	IV cefazolin 2g	IV vancomycin 15–20mg/kg	Single dose	There is no need to extend the antibiotic duration for patients who are not immunised. Administer the appropriate immunisations	GPP
<b>Whipple's operation (no recent biliary intervention/stenting)</b>					
Whipple's operation (no recent biliary intervention/ stenting)	IV cefazolin 2g Followed by: 1–2g 8h or IV ceftriaxone 2g once or IV amoxicillin-clavulanic acid 1.2g Followed by: 1.2g 8h	IV clindamycin 600–900mg or IV vancomycin 1520mg/kg +/- IV gentamicin 5mg/kg or IV aztreonam 2g	Up to 24 hours	For patients with recent biliary intervention/stenting, there is a higher incidence of bacteremia with ESBL-producing organisms. Antibiotic should be tailored according to in-house antibiogram or recent bile/ blood cultures from the patient.	Level 2+ (Grade C)
<b>Endoscopic retrograde cholangio-pancreatography (ERCP)</b>					
Endoscopic retrograde cholangio-pancreatography (ERCP)	Not recommended except in cases of incomplete biliary drainage or obstructive biliary tract disease  IV cefazolin 2g or IV ceftriaxone 2g	Not recommended except in cases of incomplete biliary drainage or obstructive biliary tract disease  IV gentamicin 5mg/kg	Single dose	Antibiotic prophylaxis for ERCP was shown to increase the proportion of resistant bacteria <sup>49-51</sup>	Level 1+ (Grade A)
<b>Obstetrics and gynaecology</b>					
Caesarean section (C-section) <sup>b</sup>	IV cefazolin 2g	IV clindamycin 900mg	Single dose	Continuation of antimicrobial prophylaxis (up to 2 days) may be considered for patients with major risk factors for surgical infections, e.g. obesity (body mass index $\geq 30$ ).	Level 1- (Grade B)

Table 3. Recommendations for surgical antibiotic prophylaxis (Cont'd)

Types of surgery	First line	Alternative for severe penicillin allergy	Duration	Remarks	Level of evidence (Grade)
Normal vaginal delivery (non-operative/instrumental)	Not recommended	Not recommended	NA	Antibiotic prophylaxis may be considered in the setting of a third- or fourth-degree perineal laceration Group B <i>Streptococcus</i> and preterm premature rupture of membranes prophylaxis are excluded in this guideline.	Level 1- (Grade B)
Normal vaginal delivery (operative/instrumental)	IV amoxicillin-clavulanic acid 1.2g	IV clindamycin 900mg	Single dose after delivery	Antibiotic prophylaxis may be considered in the setting of a third- or fourth-degree perineal laceration Group B <i>Streptococcus</i> and preterm premature rupture of membranes prophylaxis are excluded in this guideline.	Level 1- (Grade B)
Hysterectomy Abdominal/vaginal/ laparoscopic	IV cefazolin 2g + IV metronidazole 500mg	IV clindamycin 900mg + IV gentamicin 5mg/kg	Single dose		Level 2- (Grade C)
Hysteroscopy	Not recommended	Not recommended	NA	The risk of infection is very low, antibiotic prophylaxis generally not necessary unless high risk e.g. dilated fallopian tubes, history of pelvic inflammatory disease, tubal damage or abnormal tubal architecture (associated with risk of postoperative pelvic inflammatory disease/endometritis). If evidence of endometritis/infection found at point of procedure, treat accordingly.	Level 1- (Grade B)
Hysterosalpingography	Not recommended	Not recommended	NA	As above.	Level 2- (Grade C)
Endometrial biopsy, cervical tissue excision, cervical cone procedures	Not recommended	Not recommended	NA		Level 2- (Grade C)
Intrauterine device insertion	Not recommended	Not recommended	NA	Consider sexually transmitted infections screens in high-risk populations and advise to complete treatment prior procedure.	Level 1+ (Grade A)

Table 3. Recommendations for surgical antibiotic prophylaxis (Cont'd)

Types of surgery	First line	Alternative for severe penicillin allergy	Duration	Remarks	Level of evidence (Grade)
<b>Orthopaedic/spine surgery</b>					
Clean orthopaedic, non-spinal procedure with no implantation (arthroscopy, tendon repair surgery)	Not recommended	Not recommended	Single dose	Risk factors include dermatological conditions, predicted prolonged operative time, malnutrition, immunosuppressant use and poorly controlled diabetes mellitus	Level 1- (Grade B)
	For patients with risk factors IV cefazolin 2g MRSA colonised IV cefazolin 2g +/- IV vancomycin 15–20mg/kg	For patients with risk factors IV vancomycin 15–20mg/kg or IV clindamycin 600–900mg			
Clean orthopaedic surgery with implants	IV cefazolin 2g Followed by: 1–2g q8h	IV vancomycin 15–20mg/kg Followed by: 15mg/kg q12h or IV clindamycin 600–900mg Followed by: 600mg q8h	Up to 24 hours		Level 1++ (Grade A)
Wrist arthroplasty	MRSA colonised IV cefazolin 2g + IV vancomycin 15–20mg/kg Followed by: IV cefazolin 1–2g q8h + IV vancomycin 15mg/kg q12h				
Spine surgery (with and without implants)	IV cefazolin 2g Followed by: 1–2g q8h	IV vancomycin 15–20mg/kg Followed by: 15mg/kg q12h or IV clindamycin 600–900mg Followed by: 600mg q8h	Up to 24 hours		Level 1++ (Grade A)
	MRSA colonised IV cefazolin 2g + IV vancomycin 15–20mg/kg Followed by: IV cefazolin 1–2g q8h + IV vancomycin 15mg/kg q12h				
<b>Otorhinolaryngology</b>					
Clean head and neck (thyroidectomy, parotidectomy, salivary gland excisions)	Not recommended	Not recommended	NA		Level 1+ (Grade A)
Clean-contaminated head and neck	IV amoxicillin-clavulanic acid 1.2g q8h or IV cefazolin 2g q8h + IV metronidazole 500mg q8h	IV clindamycin 600–900mg q8h +/- IV gentamicin 5mg/kg once <sup>a</sup>	Up to 24 hours	Prolonged course of oral antibiotics has not been shown to reduce postoperative infections and may increase the risk of complications.	Level 1+ (Grade A)
Neck dissection procedures					For neck dissection: Level 2+ (Grade C)
Clean otologic procedures	Not recommended	Not recommended	NA		Level 1+ (Grade A)

Table 3. Recommendations for surgical antibiotic prophylaxis (Cont'd)

Types of surgery	First line	Alternative for severe penicillin allergy	Duration	Remarks	Level of evidence (Grade)
Clean-contaminated otologic procedures	IV amoxicillin-clavulanic acid 1.2g q8h or IV cefazolin 2g q8h + IV metronidazole 500mg q8h	IV clindamycin 600–900mg q8h +/- IV gentamicin 5mg/kg once <sup>a</sup>	Up to 24 hours		Level 1- (Grade B)
Tonsillectomy	Not recommended	Not recommended	NA		Level 1+ (Grade A)
Simple septorhinoplasty	Not recommended	Not recommended	NA	Infection rates are very low, especially when nasal packing/splint use $\leq$ 48 hours	Level 1- (Grade B)
Complex Septorhinoplasty	IV amoxicillin-clavulanic acid 1.2g q8h or IV cefazolin 2g q8h + IV metronidazole 500mg q8h	IV clindamycin 600–900mg q8h +/- IV gentamicin 5mg/kg once <sup>a</sup>	Up to 24 hours		Level 1- (Grade B)
Endoscopic sinus surgery	IV amoxicillin-clavulanic acid 1.2g or IV cefazolin 2g + IV metronidazole 500mg	IV clindamycin 600–900mg +/- IV gentamicin 5mg/kg <sup>a</sup>	Single dose	Post-operative antibiotics should not be given if there is no mucous seen intra-operatively.	Level 1- (Grade B)
<b>Neurosurgery</b>					
Clean wounds Elective craniotomy, external ventricular drain (EVD), intracranial pressure (ICP) monitors	IV cefazolin 2g <u>MRSA colonised</u> IV vancomycin 15–20mg/kg	IV vancomycin 15–20mg/kg or IV clindamycin 600–900mg	Single dose <sup>b</sup>		Level 1+ (Grade A) For EVD and ICP: Level 2++ (Grade B)
Clean wounds with foreign bodies or instrumentation Cerebrospinal fluid shunting procedures	IV cefazolin 2g <u>MRSA colonised</u> IV vancomycin 15–20mg/kg	IV vancomycin 15–20mg/kg or IV clindamycin 600–900mg	Single dose <sup>b</sup>		Level 1+ (Grade A)
<b>Urological procedures</b>					
Lower urinary tract instrumentation					
Cystourethroscopy -With or without minor manipulation, and without a significant break in mucosal barriers -With a significant break in mucosal barriers/significant manipulation	Not recommended, except in those with risk factors, to manage as transurethral cases (refer to the section on transurethral procedure)  To manage as transurethral cases (refer to transurethral section)	Not recommended, except in those with risk factors, to manage as transurethral cases (refer to the section on transurethral procedure)	NA	If urine culture shows no growth prior to the procedure, antimicrobial prophylaxis is not necessary  Risk factors: poor functional status/frailty, anatomic anomalies of the urinary tract, chronic steroid use, immunocompromising condition or recent systemic chemotherapy, poorly controlled diabetes mellitus, prior severe urosepsis	Level 1+ (Grade A)



Table 3. Recommendations for surgical antibiotic prophylaxis (Cont'd)

Types of surgery	First line	Alternative for severe penicillin allergy	Duration	Remarks	Level of evidence (Grade)
Transurethral cases and minimally invasive surgical therapy to the prostate	IV/IM gentamicin 3–5mg/kg or IV amoxicillin-clavulanic acid 1.2g or IV ceftriaxone 2g	IV/IM gentamicin 3–5mg/kg or PO ciprofloxacin 500mg/IV 400mg <sup>d</sup>	Single dose		Level 1+ (Grade B)
Transrectal prostate biopsy	PO ciprofloxacin 500 mg + IV/IM gentamicin 3–5mg/kg or IV amoxicillin-clavulanic acid 1.2g/ PO 625mg + IV/IM gentamicin 3–5mg/kg or IV ceftriaxone 2g	PO ciprofloxacin 500 mg + IV/IM gentamicin 3–5mg/kg	Up to 48 hours	For PO ciprofloxacin, dose 1–2 hours before the procedure  For PO amoxicillin-clavulanic acid, dose 24 hours before the procedure	Level 1+ (Grade A)
Transperineal procedures e.g. prostate brachytherapy, transperineal prostate biopsy	Not recommended	Not recommended	NA	Prophylaxis may be recommended in patients with risk factors (chronic steroid use, immunocompromising condition or recent systemic chemotherapy, poorly controlled diabetes mellitus), prior severe urosepsis or post-biopsy infection. Antibiotic choice: PO cephalosporins or amoxicillin-clavulanic acid 2 hours before the procedure	Level 2+ (Grade C)
Upper urinary tract instrumentation					
Percutaneous renal surgery, e.g. percutaneous nephrolithotomy	IV ceftazolin 2g + IV gentamicin 3–5mg/kg or IV amoxicillin-clavulanic acid 1.2g or IV ceftriaxone 2g	IV gentamicin 3–5mg/kg + IV clindamycin 600–900mg or IV gentamicin 3–5mg/kg + IV vancomycin 15–20mg/kg	Single dose		Level 1+ (Grade A)
Ureteroscopy (including laser lithotripsy)	IV gentamicin 3–5mg/kg or IV amoxicillin-clavulanic acid 1.2g or IV ceftriaxone 2g	IV gentamicin 3–5mg/kg or PO ciprofloxacin 500mg/IV 400mg <sup>d</sup>	Single dose		Level 1+ (Grade A)
Open, laparoscopic or robotic surgery					

Table 3. Recommendations for surgical antibiotic prophylaxis (Cont'd)

Types of surgery	First line	Alternative for severe penicillin allergy	Duration	Remarks	Level of evidence (Grade)
Urethroplasty; reconstruction of anterior urethra, stricture repair, including urethrectomy; controlled entry into the urinary tract e.g. renal surgery, nephrectomy, ureterectomy, pyeloplasty, radical prostatectomy; partial cystectomy	IV cefazolin 2g + IV gentamicin 3–5mg/kg or IV amoxicillin-clavulanic acid 1.2g or IV ceftriaxone 2g	IV gentamicin 3–5mg/kg + IV clindamycin 600–900mg or IV gentamicin 3–5mg/kg + IV vancomycin 15–20mg/kg	Single dose	Consider preoperative urine cultures and treat accordingly  For buccal mucosal graft, consider adding anaerobic coverage	Level 2+ (Grade B)
Urinary diversion involving small or large bowel	IV cefazolin 2g + IV gentamicin 3–5mg/kg + IV metronidazole 500mg or IV amoxicillin-clavulanic acid 1.2g or IV ceftriaxone 2g + IV metronidazole 500mg	IV gentamicin 3–5mg/kg + IV metronidazole 500 mg or IV gentamicin 3–5mg/kg + IV clindamycin 600–900mg	Single dose	Metronidazole may be optional for small bowel surgery	Level 2- (Grade C)
Implanted prosthetic devices: AUS, IPP, sacral neuromodulators	IV cefazolin 2g + IV gentamicin 3–5mg/kg or IV amoxicillin-clavulanic acid 1.2g or IV ceftriaxone 2g  <u>MRSA colonised</u> IV vancomycin 15–20mg/kg	IV vancomycin 15–20mg/kg + IV aztreonam 2g or IV clindamycin 600–900mg + IV gentamicin 3–5mg/kg	Single dose		Level 4 (GPP)
<b>Others</b>					
Urodynamic study	Not recommended except in those with risk factors (see cystourethroscopy section)	NA	NA	For shockwave lithotripsy, consider antibiotic prophylaxis (single-dose IV gentamicin or IV ceftriaxone) only if high risk of infection e.g. infected stones, recent instrumentation, nephrostomy tubes, positive urine culture, or history of recent urinary tract infection/sepsis	Level 1+ (Grade A)
Penile surgery					
Shockwave lithotripsy					

<sup>a</sup> The addition of gentamicin may be appropriate when there is an increased likelihood of Gram-negative contamination of the surgical site.

<sup>b</sup> While single-dose prophylaxis is usually sufficient, the duration of prophylaxis for all procedures should be less than 24 hours.

<sup>c</sup> Clindamycin resistance has been increasing in *Bacteroides* species. Metronidazole may be preferred if the procedure transverses the lower gastrointestinal tract.

<sup>d</sup> Due to the high local resistance of Gram-negative organisms to quinolones, this is only recommended if the organism is shown to be sensitive in the preoperative urine culture.

<sup>e</sup> An additional single dose of IV azithromycin 500mg to routine prophylaxis may be considered for a non-elective Caesarean section. However, the extrapolation of benefit to local centres where rates of post-C-section infections are low still remains to be determined.

AUS: Artificial urinary sphincter; AVF: arteriovenous fistula; AVG: arteriovenous graft; CABG: coronary artery bypass grafting; ERCP: endoscopic retrograde cholangio-pancreatography; GPP: good practice points; IPP: intravesical prostatic protrusion; IM: intramuscular; IV: intravenous; LVAD: left ventricular assist device; MRSA: methicillin-resistant *Staphylococcus aureus*; NA: not applicable; PO: per oral (oral administration); TEVAR: thoracic endovascular aortic repair; VATS: video-assisted thoracoscopic surgery  
Superscript numbers: Refer to REFERENCES

Table 4. Recommended doses and re-dosing interval

Antibiotic	Adult dose	Re-dosing interval
IV cefazolin	2g (3g if >120kg)	Every 4 hours <sup>a</sup>
IV ceftriaxone	2g	Every 12 hours
IV metronidazole	500mg	Every 8–12 hours
IV clindamycin	600–900mg	Every 4–6 hours
IV vancomycin	15–20mg/kg	Every 8–12 hours <sup>a</sup>
IV/IM gentamicin	3–5mg/kg	NA
IV amoxicillin-clavulanic acid	1.2g	Every 4 hours <sup>a</sup>
IV/PO ciprofloxacin	400mg (IV), 500mg (PO)	Every 8–12 hours <sup>a</sup>
IV aztreonam	2g	Every 4 hours <sup>a</sup>

IM: intramuscular; IV: intravenous; NA: not applicable; PO: per oral (oral administration)

<sup>a</sup>Recommended doses and re-dosing intervals are based on normal renal function. Renal dose adjustment may be required.

Source: Bratzler DW, Dellinger EP, Olsen KM, et al. Clinical practice guidelines for antimicrobial prophylaxis in surgery. *Am J Health Syst Pharm* 2013;70:195-283.

### Adjusted body weight = Ideal body weight + 0.4 x (Total body weight - Ideal body weight)

where

Ideal body weight (male) is  $50 + 2.3 \times (\text{height in inches} - 60)$

Ideal body weight (female) is  $45.5 + 2.3 \times (\text{height in inches} - 60)$

(1 inch = 2.54cm)

- For vancomycin, it should be dosed at 15–20mg/kg of actual body weight, with the first dose capped at 3g per dose.<sup>1,3,40-43</sup>

### Patients with $\beta$ -lactam allergy

$\beta$ -lactams, including cephalosporins, are the mainstay of SAP and have the highest efficacy. Studies have shown that patients with reported  $\beta$ -lactam allergy have increased odds of SSI, attributed to the receipt of second-line antibiotics.<sup>44,45</sup> Thus, patients with a history of  $\beta$ -lactam allergy should have a detailed antibiotic and allergy assessment to determine if a true allergy exists, and to exclude any non-immunological adverse reaction (for example diarrhoea, vomiting and non-specific rash). This can be done in advance for elective surgeries, so patients with no true allergy or a mild allergy to penicillin can be given the first-line SAP.

Patients with severe penicillin allergy should not receive  $\beta$ -lactam for surgical prophylaxis. These include patients with severe immunoglobulin E (IgE)-mediated reactions (anaphylaxis, urticaria, bronchospasm and angioedema), or non-IgE-mediated reactions (Steven-Johnson syndrome, toxic epidermal necrolysis and drug-induced hypersensitivity

syndrome). Alternatives to  $\beta$ -lactam antibiotics are provided in Table 3.

In patients with an uncomplicated non-IgE-mediated allergic reaction to penicillin (i.e. maculopapular rash), cephalosporins (i.e. cefazolin or 3rd generation cephalosporins) can be considered after discussion with the patient and the allergy team (if available). Cefazolin, in particular, has a unique R1 side chain that is distinct from other cephalosporins and  $\beta$ -lactams, and side chain cross-reactivity with penicillin and other beta-lactams is not expected.<sup>46,47</sup>

### Patients receiving therapeutic antibiotics for an active infection before surgery

If the antibiotic used to treat the current infection is deemed appropriate for surgical prophylaxis, an extra dose should be administered within 60 minutes before the surgical incision. If the current antibiotic is insufficient for surgical prophylaxis, the recommended antibiotic prophylaxis for the procedure should be used. The need for re-dosing should be individualised and evaluated on a case-by-case basis.

### Patients with prior colonisation or infection with multidrug-resistant pathogens

The causative link between the carriage of multidrug-resistant organisms and the resultant SSI caused by these pathogens has not been established. Whether prophylaxis should be expanded to cover these pathogens depends on many factors, including the host, the pathogen and its antimicrobial susceptibility profile, the procedure, and the proximity of the reservoir of the pathogen to the operative site.<sup>1</sup> These patients should be evaluated on a case-by-case basis.

### **Consideration for formal infectious diseases consultation**

Formal infectious diseases consultation should be considered for the following patients:

- Patients who have contraindications to both the first- and second-line antibiotic prophylaxis regimen (including complex allergy history and impaired renal function).
- Patients with a recent history of colonisation and/or infection with multidrug-resistant organisms and who are undergoing high-risk procedures.

### **Duration of surgical antibiotic prophylaxis**

In clean and clean-contaminated procedures, additional prophylactic antibiotic agents should not be administered after the surgical incision is closed, even in the presence of a drain. This recommendation also applies to patients on systemic corticosteroids or other immunosuppressive therapy.<sup>1,3</sup> At most, the duration of antibiotic prophylaxis should not exceed 24 hours for most procedures. A recent systematic review of 83 randomised controlled trials across various surgical subspecialties found no additional benefit from extending the duration of prophylaxis as compared to immediate discontinuation. A prespecified subgroup analysis in this study also showed that when best practice standards (defined as the first dose within an hour of incision and appropriate re-dosing) were applied, prolonged antibiotic prophylaxis had no effect on the risk of SSI.<sup>48</sup> Prolonged SAP beyond 24 hours has been shown to be associated with acute kidney injury and *C. difficile* infections.<sup>7</sup> This practice may also increase selective pressure favouring the emergence of multidrug-resistant organisms.<sup>8</sup> The recommended duration of antibiotic prophylaxis for various surgical procedures is provided in Table 3.

### **Recommendations for monitoring and surveillance**

The Workgroup Panel recommends the following indicators for monitoring and audit:

- The choice, dosage, and route of administration of antimicrobial agents are consistent with the national guideline.
- The first dose of prophylaxis is given at the right time in relation to the incision time.
- Re-dosing of antimicrobial agents is consistent with the national guideline.
- The duration of prophylaxis is consistent with the national guideline.

Data on the choice and duration of SAP in public hospitals in Singapore are collected annually through

the Antimicrobial Utilisation-Point Prevalence Survey (AMU-PPS). The above additional process measures may be incorporated into the AMU-PPS to provide useful information to improve antimicrobial stewardship initiatives.

### **Limitations**

Immunocompromised patients and patients colonised with multidrug-resistant organisms may be under-represented in a majority of the studies. Some of these patients who are undergoing high-risk surgeries are recommended for a formal infectious disease consultation prior to surgery. Additional limitations pertaining to the studies in certain surgical specialties were stated in the respective sections under the online Appendix 1. The cost-effectiveness of the recommended antibiotic regimen was also not discussed in this guideline. The majority of the antimicrobial agents recommended are generic formulations and of relatively low price.

### **CONCLUSION**

This is the first national surgical antibiotic prophylaxis guideline in Singapore. It provides evidence-based recommendations for the rational use of antibiotic prophylaxis—including the recommended agent(s), dose, timing and duration for adult patients undergoing elective clean or clean-contaminated surgeries. This guide aims to align best practices nationally and provide a framework for audit and surveillance. Current evidence indicates that SAP has no benefit when given beyond 24 hours, and may be associated with harm. The establishment of the national SAP guideline for hospitals in Singapore may lower the rate of SSI, while also reducing adverse events from the prolonged duration of SAP.

### **Acknowledgements**

*The full list of contributors to the guideline is stated in the online version of the guideline. We would like to thank the Antimicrobial Resistance Coordinating Office, National Centre for Infectious Diseases for providing administrative support.*

### **REFERENCES**

1. Bratzler DW, Dellinger EP, Olsen KM, et al. Clinical practice guidelines for antimicrobial prophylaxis in surgery. *Am J Health Syst Pharm* 2013;70:195-283.
2. National Antimicrobial Resistance Control Committee (2020). National Antimicrobial Resistance Control Committee (NARCC) Report on 2020 Data. [Unpublished]
3. Berríos-Torres SI, Umscheid CA, Bratzler DW, et al. Centers for Disease Control and Prevention Guideline for the Prevention of Surgical Site Infection, 2017 *JAMA Surg* 2017;152:784-91. Erratum in *JAMA Surg* 2017;152:803.



4. World Health Organization. Global Guidelines for the Prevention of Surgical Site Infection, 2018. <https://www.who.int/publications/i/item/global-guidelines-for-the-prevention-of-surgical-site-infection-2nd-ed>. Accessed 1 June 2022.
5. Phillips BT, Sheldon ES, Orhurhu V, et al. Preoperative Versus Extended Postoperative Antimicrobial Prophylaxis of Surgical Site Infection During Spinal Surgery: A Comprehensive Systematic Review and Meta-Analysis. *Adv Ther* 2020;37:2710-33.
6. McDonald M, Grabsch E, Marshall C, et al. Single- versus multiple-dose antimicrobial prophylaxis for major surgery: a systematic review. *ANZ J Surg* 1998;68:388-95.
7. Branch-Elliman W, O'Brien W, Strymish J, et al. Association of Duration and Type of Surgical Prophylaxis With Antimicrobial-Associated Adverse Events. *JAMA Surg* 2019;154:590-8.
8. Harbarth S, Samore MH, Lichtenberg D, et al. Prolonged antibiotic prophylaxis after cardiovascular surgery and its effect on surgical site infections and antimicrobial resistance. *Circulation* 2000;101:2916-21.
9. Cai Y, Venkatachalam I, Tee NW, et al. Prevalence of Healthcare-Associated Infections and Antimicrobial Use Among Adult Inpatients in Singapore Acute-Care Hospitals: Results From the First National Point Prevalence Survey. *Clin Infect Dis* 2017;64(suppl 2):S61-7.
10. The ADAPTE Collaboration (2009). The ADAPTE Process: Resource Toolkit for Guideline Adaptation. Version 2.0. <https://g-i-n.net/wp-content/uploads/2021/03/ADAPTE-Resource-toolkit-March-2010.pdf>. Accessed 19 December 2020.
11. National Institute for Health and Care Excellence. Surgical site infections: Prevention and treatment, updated 19 August 2020. [www.nice.org.uk/guidance/ng125](http://www.nice.org.uk/guidance/ng125). Accessed 9 December 2020.
12. Paterson DL. "Collateral damage" from cephalosporin or quinolone antibiotic therapy. *Clin Infect Dis* 2004;38(Suppl 4):S341-5.
13. Cho SM, Lee JJ, Yoon HJ. Clinical risk factors for Clostridium difficile-associated diseases. *Braz J Infect Dis* 2012;16:256-61.
14. van Kasteren MEE, Manniën J, Ott A, et al. Antibiotic prophylaxis and the risk of surgical site infections following total hip arthroplasty: timely administration is the most important factor. *Clin Infect Dis* 2007;44:921-7.
15. Steinberg JP, Braun BI, Hellinger WC, et al. Timing of antimicrobial prophylaxis and the risk of surgical site infections: results from the Trial to Reduce Antimicrobial Prophylaxis Errors. *Ann Surg* 2009;250:10-6.
16. Garey KW, Dao T, Chen H, et al. Timing of vancomycin prophylaxis for cardiac surgery patients and the risk of surgical site infections. *J Antimicrob Chemother* 2006;58:645-50.
17. Cotogni P, Barbero C, Passera R, et al. Violation of prophylactic vancomycin administration timing is a potential risk factor for rate of surgical site infections in cardiac surgery patients: a prospective cohort study. *BMC Cardiovasc Disord* 2017;17:73.
18. Vardakas KZ, Soteriades ES, Chrysanthopoulou SA, et al. Perioperative anti-infective prophylaxis with teicoplanin compared to cephalosporins in orthopaedic and vascular surgery involving prosthetic material. *Clin Microbiol Infect* 2005;11:775-7.
19. Periti P, Stringa G, Mini E. Comparative multicenter trial of teicoplanin versus cefazolin for antimicrobial prophylaxis in prosthetic joint implant surgery. Italian Study Group for Antimicrobial Prophylaxis in Orthopedic Surgery. *Eur J Clin Microbiol Infect Dis* 1999;18:113-9.
20. Humphreys H, Becker K, Dohmen PM, et al. *Staphylococcus aureus* and surgical site infections: benefits of screening and decolonization before surgery. *J Hosp Infect* 2016;94:295-304.
21. Kim DH, Spencer M, Davidson SM, et al. Institutional prescreening for detection and eradication of methicillin-resistant *Staphylococcus aureus* in patients undergoing elective orthopaedic surgery. *J Bone Joint Surg Am* 2010;92:1820-6.
22. Lee AS, Cooper BS, Malhotra-Kumar S, et al. Comparison of strategies to reduce methicillin-resistant *Staphylococcus aureus* rates in surgical patients: a controlled multicentre intervention trial. *BMJ Open* 2013;3:e003126.
23. Schweizer ML, Chiang HY, Septimus E, et al. Association of a bundled intervention with surgical site infections among patients undergoing cardiac, hip, or knee surgery. *JAMA* 2015;313:2162-71.
24. Edmiston CE Jr, Ledebor NA, Buchan BW, et al. Is Staphylococcal Screening and Suppression an Effective Interventional Strategy for Reduction of Surgical Site Infection? *Surg Infect (Larchmt)* 2016;17:158-66.
25. Schelenz S, Tucker D, Georgeu C, et al. Significant reduction of endemic MRSA acquisition and infection in cardiothoracic patients by means of an enhanced targeted infection control programme. *J Hosp Infect* 2005;60:104-10.
26. Lopez WY, Rider SM, Nwosu K, et al. The Impact of Vancomycin and Cefazolin as Standard Preoperative Antibiotic Prophylaxis on Surgical Site Infections Following Instrumented Spinal Fusion. *Spine (Phila Pa 1976)* 2019;44:E366-71.
27. Ponce B, Raines BT, Reed RD, et al. Surgical Site Infection After Arthroplasty: Comparative Effectiveness of Prophylactic Antibiotics: Do Surgical Care Improvement Project Guidelines Need to Be Updated? *J Bone Joint Surg Am* 2014;96:970-7.
28. Burger JR, Hansen BJ, Leary EV, et al. Dual-Agent Antibiotic Prophylaxis Using a Single Preoperative Vancomycin Dose Effectively Reduces Prosthetic Joint Infection Rates With Minimal Renal Toxicity Risk. *J Arthroplasty* 2018;33(7S):S213-18.
29. Branch-Elliman W, Ripollone JE, O'Brien WJ, et al. Risk of surgical site infection, acute kidney injury, and Clostridium difficile infection following antibiotic prophylaxis with vancomycin plus a beta-lactam versus either drug alone: A national propensity-score-adjusted retrospective cohort study. *PLoS Med* 2017;14:e1002340.
30. Courtney PM, Melnic CM, Zimmer Z, et al. Addition of Vancomycin to Cefazolin Prophylaxis Is Associated With Acute Kidney Injury After Primary Joint Arthroplasty. *Clin Orthop Relat Res* 2015;473:2197-203.
31. Zelenitsky SA, Silverman RE, Duckworth H, et al. A prospective, randomized, double-blind study of single high dose versus multiple standard dose gentamicin both in combination with metronidazole for colorectal surgical prophylaxis. *J Hosp Infect* 2000;46:135-40.
32. Dubrovskaya Y, Tejada R, Bosco J 3rd, et al. Single high dose gentamicin for perioperative prophylaxis in orthopedic surgery: Evaluation of nephrotoxicity. *SAGE Open Med* 2015;3:2050312115612803.
33. Zelenitsky SA, Ariano RE, Harding GK, et al. Antibiotic pharmacodynamics in surgical prophylaxis: an association between intraoperative antibiotic concentrations and efficacy. *Antimicrob Agents Chemother* 2002;46:3026-30.
34. Zanetti G, Giardina R, Platt R. Intraoperative redosing of cefazolin and risk for surgical site infection in cardiac surgery. *Emerg Infect Dis* 2001;7:828-31.

35. Markantonis SL, Kostopanagiotou G, Panidis D, et al. Effects of blood loss and fluid volume replacement on serum and tissue gentamicin concentrations during colorectal surgery. *Clin Ther* 2004;26:271-81.
36. Swoboda SM, Merz C, Kostuik J, et al. Does intraoperative blood loss affect antibiotic serum and tissue concentrations? *Arch Surg* 1996;131:1165-72.
37. Anaya DA, Dellinger EP. The obese surgical patient: a susceptible host for infection. *Surg Infect (Larchmt)*. 2006;7:473-80.
38. Winfield RD, Reese S, Bochicchio K, et al. Obesity and the Risk for Surgical Site Infection in Abdominal Surgery. *Am Surg* 2016;82:331-6.
39. Bauer LA, Edwards WA, Dellinger EP, et al. Influence of weight on aminoglycoside pharmacokinetics in normal weight and morbidly obese patients. *Eur J Clin Pharmacol* 1983;24:643-7.
40. Crawford T, Rodvold KA, Solomkin JS. Vancomycin for surgical prophylaxis? *Clin Infect Dis* 2012;54:1474-9.
41. Hafermann MJ, Kiser TH, Lyda C, et al. Weight-based versus set dosing of vancomycin for coronary artery bypass grafting or aortic valve surgery. *J Thorac Cardiovasc Surg* 2014;147:1925-30.
42. Crass RL, Dunn R, Hong J, et al. Dosing vancomycin in the super obese: less is more. *J Antimicrob Chemother* 2018;73:3081-6.
43. Rybak MJ, Le J, Lodise TP, et al. Therapeutic monitoring of vancomycin for serious methicillin-resistant *Staphylococcus aureus* infections: A revised consensus guideline and review by the American Society of Health-System Pharmacists, the Infectious Diseases Society of America, the Pediatric Infectious Diseases Society, and the Society of Infectious Diseases Pharmacists. *Am J Health Syst Pharm* 2020;77:835-64.
44. Lam PW, Tarighi P, Elligsen M, et al. Self-reported beta-lactam allergy and the risk of surgical site infection: A retrospective cohort study. *Infect Control Hosp Epidemiol* 2020;41:438-43.
45. Blumenthal KG, Ryan EE, Li Y, et al. The Impact of a Reported Penicillin Allergy on Surgical Site Infection Risk. *Clin Infect Dis* 2018;66:329-36.
46. Zagursky RJ, Pichichero ME. Cross-reactivity in  $\beta$ -Lactam Allergy. *J Allergy Clin Immunol Pract* 2018;6:72-81.e1. Erratum in: *J Allergy Clin Immunol Pract* 2022;10:651.
47. Romano A, Valluzzi RL, Caruso C, et al. Cross-Reactivity and Tolerability of Cephalosporins in Patients with IgE-Mediated Hypersensitivity to Penicillins. *J Allergy Clin Immunol Pract* 2018;6:1662672.
48. de Jonge SW, Boldingh QJJ, Solomkin JS, et al. Effect of postoperative continuation of antibiotic prophylaxis on the incidence of surgical site infection: a systematic review and meta-analysis. *Lancet Infect Dis* 2020;20:1182-92.
49. Minami T, Sasaki T, Serikawa M, et al. Antibiotic prophylaxis for endoscopic retrograde cholangiopancreatography increases the detection rate of drug-resistant bacteria in bile. *J Hepatobiliary Pancreat Sci* 2014;21:712-8.
50. Masadeh M, Chandra S, Livorsi D, et al. Evaluation of Biliary Bacterial Resistance in Patients with Frequent Biliary Instrumentation, One Size Does Not Fit All. *Dig Dis Sci* 2018;63:3474-9.
51. Du M, Suo J, Liu B, Xing Y, et al. Post-ERCP infection and its epidemiological and clinical characteristics in a large Chinese tertiary hospital: a 4-year surveillance study. *Antimicrob Resist Infect Control* 2017;6:131.

# The Omicron-transformer: Rise of the subvariants in the age of vaccines

Travis Ren Teen Chia<sup>1</sup>*PhD*, Barnaby Edward Young<sup>1,2,3</sup>*MB BChir*, Po Ying Chia<sup>1,2,3</sup>*MBBS*

## ABSTRACT

**Introduction:** Omicron is the latest SARS-CoV-2 variant of concern, the pathogen that causes COVID-19. Since its emergence in late 2021, Omicron has displaced other circulating variants and caused successive waves of infection worldwide throughout 2022. Omicron is characterised by the rapid emergence of many subvariants and high rates of infection in people with vaccine- and/or infection-induced immunity. This review article will consolidate current knowledge regarding Omicron subvariants, the role of boosters, and future vaccine development.

**Method:** This narrative review is based on a literature search using PubMed. Search terms related to Omicron were used and priority was given to published peer-reviewed articles over pre-prints.

**Results:** Studies indicate that vaccinations and boosters are important to reduce disease severity, hospitalisation, and death from Omicron. A variety of factors, such as differing host factors, circulating variants, and forces of infection, can influence the benefit of repeated booster administration. Next-generation bivalent vaccines have now been approved in some countries including Singapore and have demonstrated the ability to induce broad variant protection. Future third-generation vaccines involving mucosal vaccines and/or pan-sarbecovirus vaccines may provide broader and longer-lasting protection.

**Conclusion:** Due to current high levels of vaccine- and infection-induced immunity, it is likely that rates of severe illness, hospitalisation, and death due to Omicron will continue to moderate. Nevertheless, the virus is ever-changing, and public health policies, especially those related to vaccinations, will also have to continually evolve and adapt as COVID-19 transitions to endemicity.

Ann Acad Med Singap 2022;51:712-29

**Keywords:** Booster, COVID-19, infectious diseases, Omicron, vaccine

## INTRODUCTION

The emergence and evolution of SARS-CoV-2 have been publicly tracked in unprecedented detail through a combination of intensive genomic sequencing and open-access sharing of data.<sup>1</sup> This surveillance information describes how waves of COVID-19 infections have been driven by the emergence of new variants of concern (VOCs) and their subvariants. While diverse genotypes are a characteristic of RNA viruses, VOCs are defined as genetic variants with evidence of phenotypic differences—either an impact on diagnostics, treatment or vaccines, or evidence of increased transmissibility or disease severity.<sup>2</sup>

Omicron (Pango lineage B.1.1.529), the most recent VOC, was first detected in South Africa and Botswana

in November 2021, where it was associated with rapidly increasing case numbers.<sup>3</sup> Compared to previously circulating VOCs, Omicron has an unusually large number of mutations, especially in the important spike protein, with changes in 32 amino acid residues (Fig. 1).<sup>4</sup> As Omicron successfully spread across the globe to become the dominant variant, it also acquired additional mutations and formed different subvariants (Fig. 2), each with its own epidemiological, clinical, and viral characteristics.

This review article aims to provide a succinct summary of the current knowledge regarding Omicron and its subvariants, including epidemiology, immune evasion, vaccine effectiveness/efficacy (mainly mRNA vaccines), and future vaccine development. In so doing, we will

<sup>1</sup> Infectious Disease Research and Training Office, National Centre for Infectious Diseases, Singapore

<sup>2</sup> Department of Infectious Diseases, Tan Tock Seng Hospital, Singapore

<sup>3</sup> Lee Kong Chian School of Medicine, National Technological University, Singapore

Correspondence: Dr Barnaby Edward Young, National Centre for Infectious Diseases, 16 Jalan Tan Tock Seng, Singapore 308442.

Email: [Barnaby\\_young@ncid.sg](mailto:Barnaby_young@ncid.sg)

## CLINICAL IMPACT

### What is New

- COVID-19 vaccination is important to minimise symptoms of Omicron and reduce the probability of severe illness, hospitalisation, and death, especially for the older adults.
- Boosters offer a short-term boost for protection against Omicron infection but more importantly, their protective effect against severe outcomes declines compared to primary series.
- Evidence of benefit from repeated boosters is strongest in people with weaker immunity such as older adults.
- Bivalent and multivalent COVID-19 vaccines show great promise to induce pan-variant protection.

### Clinical Implications

- This review can help guide clinicians and policymakers in deciding which patients should be prioritised for booster vaccination.

consider the role of first and second vaccine booster doses, and suggest clinical guidance on their administration, based on the latest available data.

## METHOD

This narrative review is based on a literature search using PubMed. Search terms used were “Omicron epidemiology”, “Omicron emergence”, “Omicron booster”, “Omicron third dose”, “Omicron fourth dose”, “Omicron targeting vaccine”, “Omicron bivalent vaccine”, and “Omicron multivalent vaccine”. Priority was given to published peer-reviewed articles over pre-prints.

## RESULTS

### Epidemiology of Omicron and subvariants

After its detection in November 2021,<sup>5,6</sup> Omicron rapidly replaced Delta as the dominant circulating variant worldwide.<sup>5,7</sup> The first Omicron outbreaks were by subvariant BA.1, which in various countries peaked around December 2021 to February 2022.<sup>7-9</sup> By March 2022, the BA.2 subvariant had displaced BA.1,<sup>10,11</sup> and within different regions, divergent sublineages such as BA2.1.1 and BA2.12.1 established themselves in France and the US, respectively.<sup>12,13</sup>

In April 2022, hybrid recombinant variants were detected. There were concerns these could become the

next dominant variants and combine the severity of Delta infection with the transmissibility of Omicron.<sup>14-16</sup> However, that did not come to pass; by June 2022, new BA.4 and BA.5 subvariants had emerged and became increasingly prevalent.<sup>17</sup> BA.5 is presently the dominant subvariant worldwide.<sup>17</sup> More recently, BA.2.75.2 and BA.4.6 have emerged and there are concerns of a new wave of infections due to their immune evasion capability (Figs. 1 and 2).<sup>18,19</sup> Also recently in Singapore, there has been a sharp uptick in new cases due to the Omicron hybrid subvariant XBB (Fig. 3). Such rapid emergence and establishment of different Omicron subvariants complicate the development of variant-specific vaccines, as vaccine candidates may be outdated by the time they enter clinical trials, let alone clinical use.

### Pathological characteristics of Omicron compared to Delta

There is currently good evidence that Omicron causes significantly less severe disease than Delta. For example, in a study involving patients admitted from Paris emergency departments, Omicron was independently associated with better hospital outcomes compared to Delta, with a decrease in intensive care unit (ICU) admission by 11.4%, mechanical ventilation by 3.6%, and mortality by 4.2% (differences were adjusted for the number of vaccine doses).<sup>20</sup> Overall, the rates of severe disease with Omicron among vaccinated individuals are comparable to seasonal influenza, though the public health impact has remained significant due to the extraordinarily high number of cases. The lower virulence has been partially attributed to changes in virus receptor binding that reduced Omicron’s efficiency at infecting cells in the lungs and gut, but not the upper airways.<sup>21</sup>

The higher number of Omicron cases can be attributed to the higher transmissibility and infectivity compared to previous variants, with an effective reproduction number of 4.20 (BA.1/2), which is triple that of Delta.<sup>22</sup> Viral factors such as increased angiotensin-converting enzyme-2 receptor affinity might contribute to this increased transmissibility.<sup>21</sup> Furthermore, Omicron is effective at evading host immunity and can infect vaccinated individuals (vaccine escape) or recovered individuals infected with non-Omicron variant (re-infection).<sup>3,23</sup> As the average healthcare burden per infected individual is reduced, many countries in the midst of re-opening borders and stepping down public health measures continued to do so.<sup>24</sup> These policy shifts also facilitated rapid transmission of the Omicron subvariants.



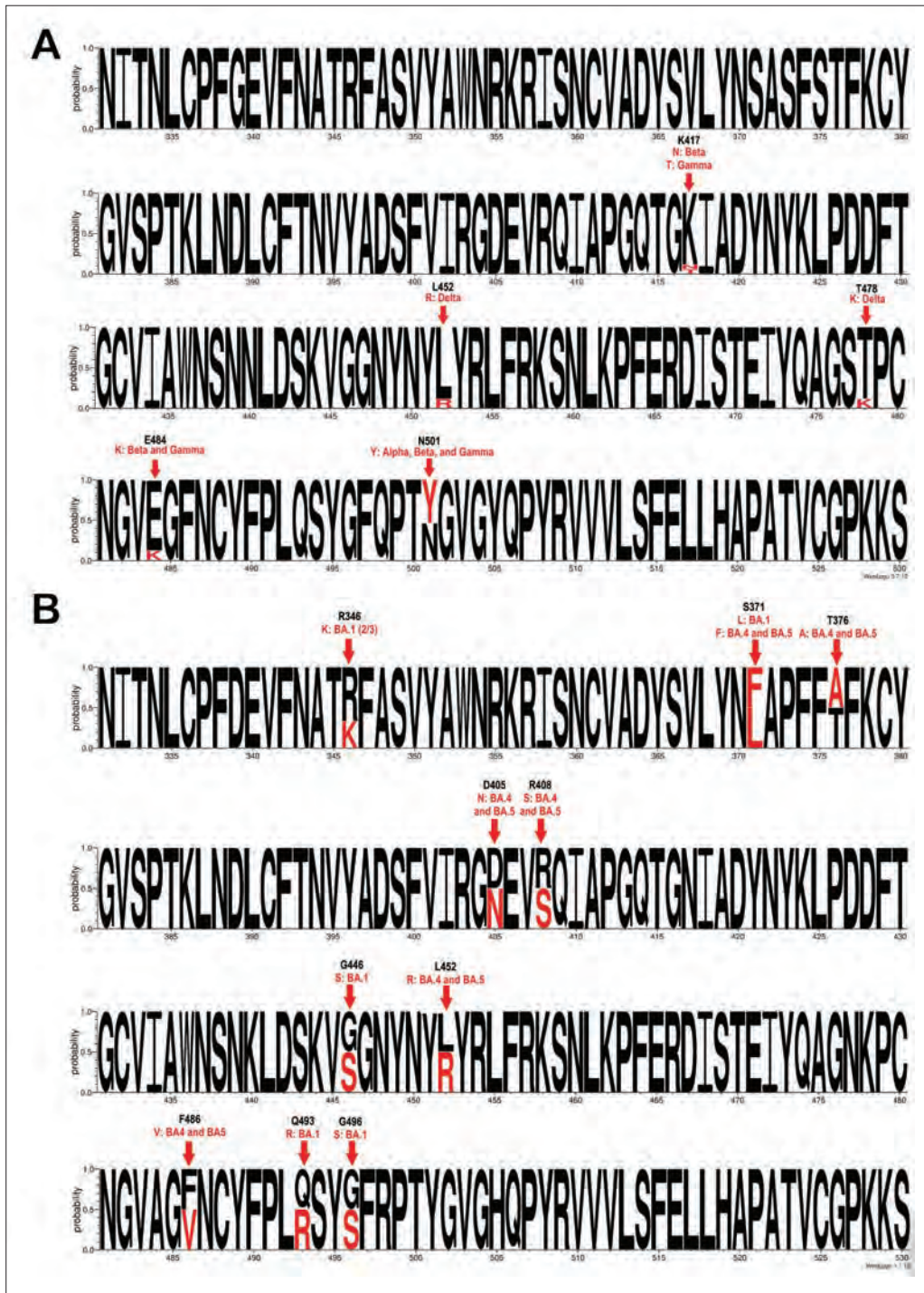

Fig. 1. Variation in receptor-binding domain of COVID-19 spike glycoprotein.

Receptor-binding domains (residues 331 to 524) of COVID-19 spike glycoprotein sequences from the National Center for Biotechnology Information, US data package (accessed 4 August 2022) were separated into non-Omicron (A) and Omicron (B) for analysis (extracted by searching for the variant name and Pango lineage). Sequences without a complete receptor-binding domain were excluded from the analysis. Black letters represent original wildtype sequence while red letters represent mutations. (A) Inter-variant variation in receptor-binding domain across wildtype, Alpha, Beta, Gamma and Delta are highlighted in red (total positions with inter-variant variation: 5). (B) Intra-variant variation in receptor-binding domain across Omicron subvariants are highlighted in red (total positions with intra-variant variation: 10). In total, 31 wildtype, 37 Alpha, 5 Beta, 6 Gamma and 10 Delta sequences were analysed for non-Omicron (total 89) while 3 BA.1, 1 BA.4 and 2 BA.5 sequences were analysed for Omicron (total 6). Y-axis represents the percentage of sequences analysed that possessed a particular amino acid residue at that position. There is greater intra-variant variation in the receptor-binding domain of the spike glycoprotein of Omicron than inter-variant variation in non-Omicron variants despite analysing far fewer Omicron sequences than non-Omicron.

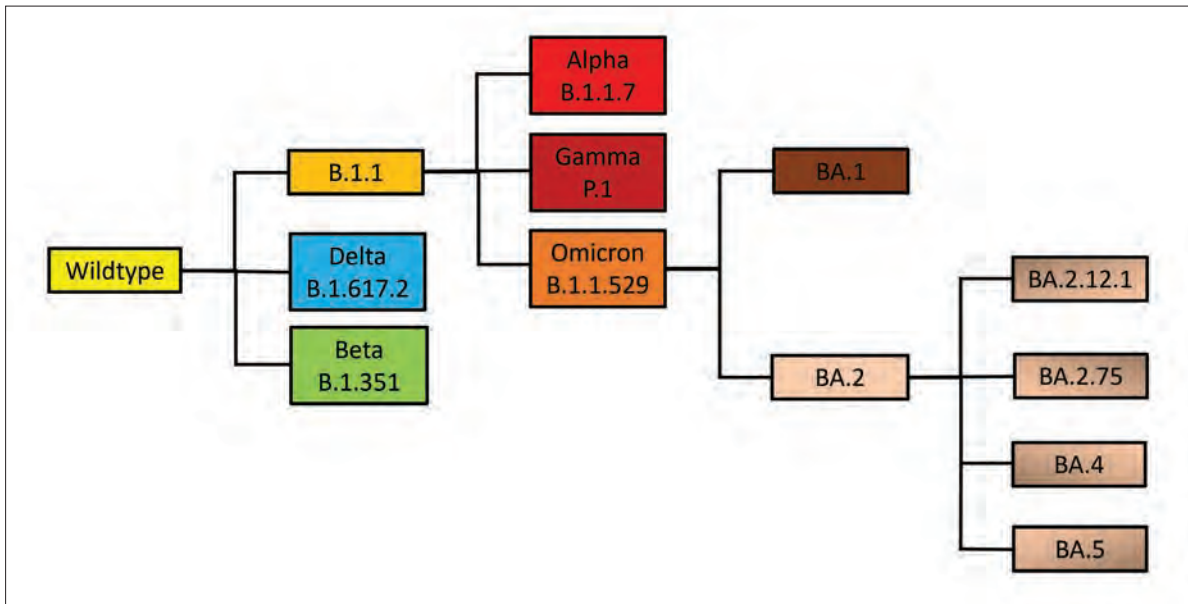

Fig. 2. Phylogeny of the spike glycoprotein of COVID-19 variants of concern. How the various COVID-19 variants of concern are related to each other based on data from NextStrain.

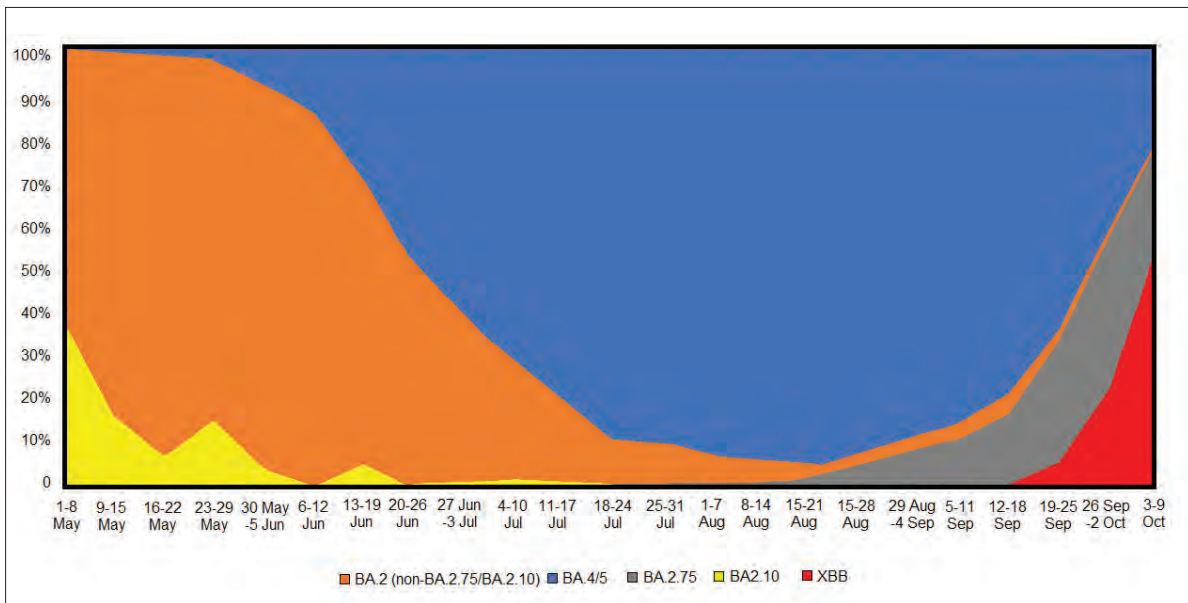

Fig. 3. Relative prevalence of Omicron subvariants in Singapore from May to October 2022. Source: Ministry of Health, Singapore. Update on COVID-19 situation and measures to protect healthcare capacity, Annex, updated 15 October 2022. <https://www.moh.gov.sg/docs/librariesprovider5/default-document-library/annexad79528af5784a1b8c95c986c82e3131.pdf>. Accessed 24 November 2022.

**Immune evasion potential of more recent Omicron subvariants**

Current epidemiological evidence indicates that BA.4 and BA.5 exhibit higher transmissibility compared to BA.1 and BA.2.<sup>6,8,25</sup> This may be due to BA.4 and BA.5 evading neutralising antibodies induced by BA.1 infection, resulting in an increased risk of re-infection.<sup>26-28</sup> Vaccinated persons with previous SARS-CoV-1 infection (the causative agent of the 2002–2004

severe acute respiratory syndrome epidemic) possess protective antibodies against BA.1, but these same antibodies conferred markedly reduced protection against BA.2.12.1, BA.4 and BA.5.<sup>26,27</sup> BA.2.12.1, BA.4 and BA.5 also display stronger neutralisation evasion of 3-dose vaccination regimens than BA.1 and BA.2.<sup>26,27</sup> Similar to how the initial Omicron subvariants (BA.1 and BA.2) had increased immune escape compared to Delta, the new Omicron subvariants have superseded

their predecessors. Given the increase in vaccination and infection rates over time and thus increase in positive selection pressure, it is unsurprising that new “successful” COVID-19 variants have stronger immune escape ability.

### **Benefits of primary mRNA vaccine series in the context of Omicron immune evasion**

Despite the lower severity of Omicron infection and its propensity to evade vaccine- and infection-induced immunity, vaccination remains a cornerstone of the COVID-19 public health response. For unvaccinated individuals with infection-derived immunity, cellular immune responses are comparable to vaccinated individuals, even though humoral immunity is lower.<sup>29-31</sup> This robust T-cell response may provide protection against severe illness in the event of re-infection. The breadth of the immune response in unvaccinated individuals infected with Omicron BA.1 is however narrower than in vaccinated individuals, particularly against non-Omicron variants.<sup>32</sup> Unvaccinated BA.1 convalescent individuals, compared to vaccinated individuals, also demonstrated a greater decrease in neutralisation against BA.4 and BA.5 (both of which are capable of evading BA.1 induced immunity).<sup>28</sup> As such, vaccination of Omicron-convalescent individuals remains beneficial.

Vaccinations are also important to minimise symptoms and reduce the risk of severe disease, critical illness and death, especially for older adults.<sup>33,34</sup> Long-term symptoms of COVID-19 (long COVID) are also a major public health concern. A UK study found that vaccination sharply reduces the probability of long COVID even after 6 months post-second dose (0.24 to 0.5 time as likely to get long COVID)<sup>35</sup> in spite of a likely significant antibody titre decay.<sup>36-39</sup>

Decay in circulating antibody titres after vaccination or infection is inevitable. However, it is important to consider other facets of the immune system. Firstly, cellular immunity is likely to be important for protection against severe disease (but is more complex to measure than antibody levels). Secondly, mucosal immune response following infection may offer additional protection against re-infection but may not correlate with systemic measures of immunity.<sup>40-42</sup> Finally, both humoral and cellular immune memory are likely to be long-lasting. Studies have demonstrated that the 2-dose primary series of mRNA vaccines continue to offer >70% protection against hospitalisation, severe illness and death even if the last dose was administered more than 6 months prior to breakthrough

infection.<sup>43,44</sup> Protection against severe disease lasts significantly longer and decays at a slower rate compared to protection against infection.<sup>36,45,46</sup> Collectively, completing the primary vaccination series provides significant benefits despite Omicron’s lower mortality and higher immune evasion ability.

### **Role of the first booster**

Repeated antigen exposures through vaccination and infection result in immune response maturation. Seven months after the second dose, Omicron variant neutralising antibodies were only detected at significant levels in 55% of patients, and were markedly lower among older adults and men.<sup>37,39</sup> The first booster after a 2-dose primary mRNA series significantly boosts circulating antibody levels, and induces a more effective response against Omicron, when compared to no booster.<sup>37,47-51</sup> In a clinical trial of mRNA boosters, Omicron neutralisation (measured by a multiplex surrogate virus neutralisation test) increased from 26.2% to 82.5% 28 days after homologous boosting (28.6% to 84.2% for heterologous boosting),<sup>39</sup> even though neutralisation activity elicited against Omicron is still comparatively lower than that against the ancestral and Delta variants.<sup>48,52-54</sup> Whether boosting with a heterologous vaccine to the primary series offers significant additional benefits remains unclear.<sup>38,39,49,50</sup>

The mRNA vaccines are effective at inducing cellular immunity, and mRNA boosters significantly increase the number of virus-specific memory B- and T-cells.<sup>38</sup> This increase in both humoral and cellular immunity by the first booster may account for the 90% lower mortality rate in people who received the booster.<sup>55</sup> As such, the evidence for the benefits of the first booster is highly compelling for all individuals.

### **Evidence for the second booster**

The role of second boosters on the other hand is more complicated. An *in vitro* study showed that the second mRNA booster dose induces broadly neutralising antibodies (bNAbs) that are effective against BA.1, BA.1.1, BA.2 and BA.3 Omicron subvariants.<sup>56</sup> A UK clinical trial, COV-BOOST, demonstrated similar findings; the second mRNA booster significantly increases both cellular and humoral immunity to a level that is equal to or exceeds the first mRNA booster and is well-tolerated.<sup>57</sup> However, there was also evidence of limited additional boost from the second booster when pre-booster immunity is already high. This was particularly evident among individuals with prior infection. Crucially, this is not “immune exhaustion”



(where pre-existing low immunity cannot be increased due to prior vaccinations) but rather an “immune ceiling” (a maximum limit to the extent humoral and cellular immunity can be boosted). Such ceiling effects have also been observed in influenza wherein subjects with high pre-vaccination antibody titres do not experience significant increase in protection.<sup>58</sup> This also has to be distinguished from immune tolerance where there is modulation in the immune response to minimise damage to the host and is also observed for influenza vaccines.<sup>59–61</sup> Since significant boosting can still be induced in subjects with low levels of protection and no significant improvement is seen when pre-booster immunity is already high, this is more likely to be due to the ceiling effect.<sup>57</sup> Therefore, repeated boosters can offer significant improvement in protection if timed when existing immunity has waned.

A recent observational study in Israel showed that while a second mRNA booster provided significant increased protection against infection by the Omicron variant, this protection peaked at fourth week post-vaccination and waned thereafter.<sup>45,62</sup> Protection against severe illness however, is expected to wane more slowly, similar to previous studies on the first mRNA booster.<sup>45</sup>

Another recently published study showed that a second booster dose of BNT162b2 vaccine offers strong protection against hospitalisation (64%) and deaths (72%),<sup>63</sup> and a mild-to-moderate protection (34%) against infection (Table 1). While this vaccine effectiveness is apparently lower than previous reported effectiveness for the primary vaccines series (e.g. 90% for BNT162b2 against hospitalisation or death),<sup>64</sup> change in comparator groups should be recognised, where current comparator groups likely have background immunity from prior vaccination or infection and are not immunologically naive. In addition, with the extremely high community prevalence of COVID-19 during Omicron waves, a substantial proportion of infected individuals are hospitalised with Omicron infection rather than because of it (“incidental COVID”). Finally, estimates of the effectiveness of boosters have to date relied on observational studies, rather than randomised clinical trials powered to determine vaccine efficacy. Therefore, one must be cautious when comparing vaccine efficacy/effectiveness across different studies. It would also be prudent to differentiate laboratory endpoints, such as neutralisation titres, from clinical outcomes that are arguably more meaningful.

Repeated boosters however may incur socioeconomic costs that need to be weighed against potential benefits

when deciding the frequency of boosters. For young and healthy individuals, the benefits of a second booster may be marginal as demonstrated by a healthcare worker study in Israel where vaccine effectiveness against symptomatic diseases was only 31–43%.<sup>65</sup>

For older adults, vaccination and boosters consistently provide significant protection.<sup>33,34</sup> Data from the US Centers for Disease Control and Prevention currently indicate that in June 2022, a second booster for people over 50 years old decreases risk of COVID-19 mortality by a factor of 3 compared to those with a single booster.<sup>66</sup> This is corroborated by a study from Arbel et al., demonstrating a substantial reduction in hospitalisation and deaths among people aged 60 and older who have received 2 boosters compared to those who have only received one.<sup>67</sup> One possible reason why older adults gain more from repeated boosters is the “immune ceiling” effect as previously discussed, coupled with the observed trend that protection in older adults tends to wane faster.<sup>68</sup> As such, the evidence for second boosters for older adults is stronger compared to the younger population.

Overall, current evidence for vaccination including boosters of the vulnerable population is strong. Nonetheless, any public health policy on vaccination should factor in predicted levels of community cases, given that such protection wanes over time, and monitor closely changes in pathogenicity and virulence of dominant circulating strains. Given the lower virulence of circulating Omicron subvariants, mandatory repeated vaccinations of non-vulnerable populations are not supported by currently available evidence.

### Omicron-targeting vaccine strategies

Much work is currently being conducted to develop an Omicron-targeting vaccine. A booster matched to Omicron spike protein successfully boosted rhesus macaques after completion of the 2-dose primary vaccine regimen (Table 2).<sup>69</sup> However, other Omicron-targeted vaccine strategies have been less successful; these vaccines induced neutralising antibodies in mice specific to Omicron but few-to-none against other variants.<sup>70–73</sup> This corresponds with another study of unvaccinated BA.1 convalescent individuals, wherein the neutralising antibodies demonstrated lower cross-reactivity against non-Omicron variants and Omicron BA.2, when compared to vaccinated individuals.<sup>32</sup> Interestingly, vaccines targeting Delta-induced neutralising antibodies were active against all variants tested in mice<sup>70,71</sup> (Table 2). Collectively, these studies suggest Omicron-targeting vaccine strategies may be challenging.



Table 1. Representative comparison of vaccine effectiveness against SARS-CoV-2 infection across different studies during period of predominant Omicron infection

Vaccine dosage	Comparator group	Population	Number of weeks since last dose	Reported vaccine effectiveness (%)	Reference
BNT162b2 (Primary)	COVID-negative	Adult (27 Nov 2021 to 12 Jan 2022)	2–4	65.5	<sup>68</sup>
			>25	8.8	
BNT162b2 (First booster, primary: ChAdOx1 nCoV-19)			2–4	62.4	
			>10	39.6	
mRNA-1273 (First booster, primary: ChAdOx1 nCoV-19)			2–4	70.1	
			5–9	60.9	
mRNA-1273 (First booster, primary: ChAdOx1 nCoV-19)			2–4	73.9	
			5–9	64.4	
BNT162b2 (Second booster)	BNT162b2 (First booster)	Long-term care facility resident (10 January 2022 to 31 March 2022)	>1	34	<sup>63</sup>

Superscript reference numbers: Refer to REFERENCES

### Bivalent and multivalent vaccines

There has been modest success in the development of pan-variant vaccines and these target antigens from multiple SARS-CoV-2 variants (Table 3). For example, a trivalent vaccine developed by combining the Sinopharm HB02 antigen, and Delta- and Omicron-targeting antigens, could induce bNABs in mice against all variants tested including HB02, Beta, Delta and Omicron.<sup>74</sup> Likewise, another trivalent vaccine targeting ancestral, Beta and Delta spike proteins induced the production of bNABs in mice against all COVID-19 variants tested.<sup>75</sup> The vaccine candidates most advanced in the development pathway are from Moderna and Pfizer-BioNTech.

As part of the ongoing COVE clinical trial (NCT04927065), Moderna has been developing bivalent vaccines targeting various COVID-19 variants. Their bivalent vaccine combining the currently approved mRNA-1273 vaccine antigen with an Omicron BA.1-targeting antigen induced high titres of bNABs against all COVID-19 variants and Omicron subvariants tested

(BA.4/BA.5).<sup>76</sup> Interestingly, their bivalent vaccine utilising Beta-targeting antigen instead of Omicron also showed similar effectiveness.<sup>77</sup> Both vaccines have similar safety profiles as the currently approved Moderna vaccine.<sup>76,77</sup>

Pfizer/BioNTech has also been able to develop their version of a bivalent vaccine that targets the ancestral variant and BA.4/BA.5;<sup>78</sup> it was reported to successfully neutralise all strains including various Omicron subvariants (BA.1, BA.2, BA.2.12.1, and BA.4/5). Another bivalent vaccine targeting the ancestral strain and BA.1, administered as a 2-dose primary series in mice, also successfully neutralised all strains tested. However, when used as a first booster, the neutralisation activity was reduced against BA.4 and BA.5. Given their success in animal models, it is unsurprising that both Moderna and Pfizer's bivalent vaccines have been approved in some countries under emergency use. As more countries around the world authorise the use of these next-generation vaccines, it is hoped that subsequent broader protection can reduce the pool

Table 2. Summary of neutralisation assay results of COVID-19 variant-targeting vaccine studies

Vaccine target	Vaccine regimen	Population	Test target	Result*	Reference
mRNA-1273	2-dose primary series taken 4 weeks apart	Rhesus macaques	Ancestral	Neutralising	69
			Beta	Neutralising	
			Delta	Neutralising	
			BA.1	Neutralising	
Beta			Ancestral	Neutralising	
			Beta	Neutralising	
			Delta	Neutralising	
			BA.1	Neutralising	
BA.1			Ancestral	Neutralising, lower than BA.1 test target	
			Beta	Neutralising, lower than BA.1 test target	
			Delta	Neutralising, lower than BA.1 test target	
			BA.1	Neutralising	
mRNA-1273	First booster taken 35 weeks since last dose of 2-dose primary series mRNA-1273		Ancestral	Successfully boosted	
			Beta	Successfully boosted	
			Delta	Successfully boosted	
			BA.1	Successfully boosted	
			BA.2	Successfully boosted	
BA.1			Ancestral	Successfully boosted	
			Beta	Successfully boosted	
			Delta	Successfully boosted	
			BA.1	Successfully boosted	
			BA.2	Successfully boosted	
Ancestral	2-dose primary series taken 2 weeks apart	Mice	Ancestral	Neutralising	70
			Beta	Neutralising	
			Delta	Neutralising	
			Omicron	Low neutralisation	
Delta			Ancestral	Neutralising	
			Beta	Neutralising	
			Delta	Neutralising	
			Omicron	Neutralising	
Omicron			Ancestral	Failed to neutralise	
			Beta	Failed to neutralise	
			Delta	Failed to neutralise	
			Omicron	Neutralising	
Delta-Omicron hybrid			Ancestral	Low neutralisation	

Table 2. Summary of neutralisation assay results of COVID-19 variant-targeting vaccine studies (Cont'd)

Vaccine target	Vaccine regimen	Population	Test target	Result*	Reference
			Beta	Low neutralisation	
			Delta	Low neutralisation	
			Omicron	Neutralising	
Ancestral	2-dose primary series taken 2 weeks apart	Mice	Ancestral	Neutralising	<sup>71</sup>
			Alpha	Neutralising	
			Beta	Neutralising	
			Omicron	Failed to neutralise	
Beta			Ancestral	Neutralising	
			Alpha	Neutralising	
			Beta	Neutralising	
			Omicron	Failed to neutralise	
Delta			Ancestral	Neutralising	
			Alpha	Neutralising	
			Beta	Neutralising	
			Delta	Neutralising	
			Omicron	Neutralising	
Omicron			Ancestral	Failed to neutralise	
			Delta	Failed to neutralise	
			Omicron	Neutralising	
Beta	First booster taken 7 weeks after last dose of 2-dose primary series targeting Delta variant		Delta	Failed to boost	
			Omicron	Failed to boost	
Delta			Delta	Successfully boosted	
			Omicron	Successfully boosted	
Omicron			Delta	Failed to boost	
			Omicron	Failed to boost	
Ancestral	2-dose primary series taken 2 weeks apart	Mice	Ancestral	Neutralising	<sup>72</sup>
			Delta	Neutralising	
			Omicron	Low neutralisation	
Omicron			Ancestral	Failed to neutralise	
			Delta	Failed to neutralise	
			Omicron	Neutralising	
Ancestral	2-dose primary series taken 2 weeks apart	Mice	Ancestral	Neutralising	<sup>73</sup>
			Alpha	Neutralising	
			Beta	Neutralising	

Table 2. Summary of neutralisation assay results of COVID-19 variant-targeting vaccine studies (Cont'd)

Vaccine target	Vaccine regimen	Population	Test target	Result*	Reference
			Gamma	Neutralising	
			Delta	Neutralising	
			BA.1	Low neutralisation	
BA.1			Ancestral	Failed to neutralise	
			Alpha	Failed to neutralise	
			Beta	Low neutralisation	
			Gamma	Low neutralisation	
			Delta	Failed to neutralise	
			BA.1	Neutralising	
Ancestral	First booster taken 2 weeks after last dose of 2-dose primary series targeting ancestral variant		Ancestral	Neutralising	
			Alpha	Neutralising	
			Beta	Neutralising	
			Gamma	Neutralising	
			Delta	Neutralising	
			BA.1	Low neutralisation	
			BA.2	Low neutralisation	
BA.1			Ancestral	Neutralising	
			Alpha	Neutralising	
			Beta	Neutralising	
			Gamma	Neutralising	
			Delta	Neutralising	
			BA.1	Neutralising	
			BA.2	Neutralising	
BA.1	First booster taken 2 weeks after last dose of 2-dose primary series targeting BA.1 subvariant		Ancestral	Failed to neutralise	
			Alpha	Neutralising	
			Beta	Neutralising	
			Gamma	Neutralising	
			Delta	Low neutralisation	
			BA.1	Neutralising	
			BA.2	Neutralising	
Ancestral	2-dose primary series taken 3 weeks apart	Mice	Ancestral	Neutralising	78
			Beta	Neutralising	
			Delta	Neutralising	



Table 2. Summary of neutralisation assay results of COVID-19 variant-targeting vaccine studies (Cont'd)

Vaccine target	Vaccine regimen	Population	Test target	Result <sup>a</sup>	Reference
			BA.1	Low neutralisation	
			BA.4/5	Low neutralisation	
BA.1			Ancestral	Low neutralisation	
			Beta	Low neutralisation	
			Delta	Low neutralisation	
			BA.1	Neutralising	
			BA.4/5	Neutralising	
Ancestral	First booster taken 104 days since 2-dose primary BNT162b2		Ancestral	Successfully boosted	
			BA.1	Lower boosting	
			BA.2	Lower boosting	
			BA.2.12.1	Lower boosting	
			BA.4/5	Lower boosting	
BA.1			Ancestral	Successfully boosted	
			BA.1	Successfully boosted	
			BA.2	Lower boosting	
			BA.2.12.1	Lower boosting	
			BA.4/5	Lower boosting	
BA.4/BA.5			Ancestral	Successfully boosted	
			BA.1	Successfully boosted	
			BA.2	Successfully boosted	
			BA.2.12.1	Successfully boosted	
			BA.4/5	Successfully boosted	

<sup>a</sup> Neutralisation levels refer to ID<sub>50</sub> values against target variant. Boosting levels mean neutralisation levels to target variant were compared before and after boosting.

Superscript reference numbers: Refer to REFERENCES

of infected populations and thus reduce the speed at which SARS-CoV-2 evolves.

### Third-generation vaccines

For the future, third-generation vaccines focusing on a pan-sarbecovirus rather than a pan-variant vaccine are in the initial stages of development. The sarbecovirus subgenus includes SARS-CoV-1, SARS-CoV-2, and other closely related viruses that have to date only been detected in animals. Pan-sarbecovirus neutralising antibodies have been detected in COVID-19 vaccinated SARS-CoV-1 survivors from Singapore, and are undergoing further characterisation.<sup>79</sup> Although there

are some early suggestions that BA.4 and BA.5 might be able to evade pan-sarbecovirus antibodies,<sup>26</sup> it is hoped that enough humoral and cellular protection could be provided by such vaccines to offer stronger, broader, and more long-lasting protection against future COVID-19 variants and other emerging sarbecoviruses.

Another possible direction that these third-generation vaccines could take includes mucosal vaccines for COVID-19.<sup>42</sup> Similar vaccines are already in use for other respiratory pathogens such as influenza A viruses<sup>80</sup> and there are groups developing a nasal spray vaccine for COVID-19.<sup>81-83</sup> For instance, the interim review of the Patria study (NCT04871737) on the

Table 3. Summary of results of bivalent and multivalent vaccine studies using neutralisation assay

Vaccine target	Vaccine regimen	Population	Test target	Result <sup>a</sup>	Reference
Delta-Omicron bivalent	2-dose primary series taken 2 weeks apart	Mice	Ancestral	Neutralising	70
			Beta	Neutralising	
			Delta	Neutralising	
			Omicron	Neutralising	
Ancestral-Omicron bivalent	Three doses of the same vaccine in 2-week intervals	Mice	Ancestral	Neutralising	73
			Alpha	Neutralising	
			Beta	Neutralising	
			Gamma	Neutralising	
			Delta	Neutralising	
			BA.1	Neutralising	
BA.2	Neutralising				
Ancestral-Omicron bivalent	Second booster taken ~134–136 days (median) since first booster, 2-dose primary series and first booster are all mRNA-1273	Humans (Excludes those with SARS-CoV-2 infection within 3 months)	Ancestral	Non-inferior boosting to mRNA-1273 booster	76 COVE (NCT04927065)
			Alpha	Significantly higher boosting to mRNA-1273 booster	
			Beta	Significantly higher boosting to mRNA-1273 booster	
			Gamma	Significantly higher boosting to mRNA-1273 booster	
			Delta	Significantly higher boosting to mRNA-1273 booster	
			BA.1	Superior boosting to mRNA-1273 booster	
BA.4/BA.5	Successfully boosted				
Ancestral-Beta bivalent	First booster taken ~8.8–9.8 months since 2-dose primary mRNA-1273 series	Humans (Excludes those with prior SARS-CoV-2 infection)	Ancestral	Superior boosting to mRNA-1273 booster	77 COVE (NCT04927065)
			Beta	Superior boosting to mRNA-1273 booster	
			Delta	Superior boosting to mRNA-1273 booster	
Ancestral	2-dose primary series taken 3 weeks apart	Mice	Ancestral	Neutralising	74
			Beta	Low neutralisation	
			Delta	Neutralising	

Table 3. Summary of results of bivalent and multivalent vaccine studies using neutralisation assay (Cont'd)

Vaccine target	Vaccine regimen	Population	Test target	Result <sup>a</sup>	Reference
Ancestral-Delta bivalent			Ancestral	Neutralising	
			Beta	Neutralising	
			Delta	Neutralising	
			BA.1	Low neutralisation	
Ancestral-Beta-Delta trivalent			Ancestral	Neutralising	
			Beta	Neutralising	
			Delta	Neutralising	
Ancestral-BA.1 bivalent			Ancestral	Neutralising	
			Beta	Neutralising	
			Delta	Neutralising	
			BA.1	Neutralising	
Ancestral-Delta-BA.1 trivalent			Ancestral	Neutralising	
			Beta	Neutralising	
			Delta	Neutralising	
			BA.1	Neutralising	
Ancestral-Beta-Delta-BA.1 tetravalent			Ancestral	Neutralising	
			Beta	Neutralising	
			Delta	Neutralising	
			BA.1	Neutralising	
Ancestral	2-dose primary series taken 3 weeks apart	Mice	Ancestral	Neutralising	75
			Beta	Low neutralisation	
			Delta	Neutralising	
			Omicron	Failed to neutralise	
Delta			Ancestral	Low neutralisation	
			Beta	Low neutralisation	
			Delta	Neutralising	
			Omicron	Low neutralisation	
Ancestral-Delta bivalent			Ancestral	Neutralising	
			Beta	Low neutralisation	
			Delta	Neutralising	
Ancestral-Beta-Delta trivalent			Ancestral	Neutralising	
			Beta	Low neutralisation	
			Omicron	Low neutralisation	

Table 3. Summary of results of bivalent and multivalent vaccine studies using neutralisation assay (Cont'd)

Vaccine target	Vaccine regimen	Population	Test target	Result <sup>a</sup>	Reference
			Beta	Neutralising	
			Delta	Neutralising	
			Omicron	Neutralising	
Ancestral-Beta-Gamma-Delta tetravalent			Ancestral	Neutralising	
			Beta	Neutralising	
			Delta	Neutralising	
			Omicron	Neutralising	
Ancestral-BA.1 bivalent	2-dose primary series taken 3 weeks apart	Mice	Ancestral	Neutralising	<sup>78</sup>
			Beta	Neutralising	
			Delta	Neutralising	
			BA.1	Neutralising	
			BA.4/5	Neutralising	
Ancestral-BA.1 bivalent	First booster taken 1 month since 2-dose primary BNT162b2		Ancestral	Successfully boosted	
			BA.1	Less boosting compared to ancestral target	
			BA.4/5	Less boosting compared to BA.1 target	
Ancestral	Second booster taken ~6.3 months (median) since first booster, 2-dose primary series and first booster are all BNT162b2	Humans	BA.1	Successfully boosted	
			BA.4/5	Less boosting compared to BA.1 target	
Ancestral-BA.1 bivalent			BA.1	Superior boosting to BNT162b2 booster	
			BA.4/5	Less boosting compared to BA.1 target	
Ancestral-BA.4/5 bivalent	First booster taken 104 days since 2-dose primary BNT162b2	Mice	Ancestral	Successfully boosted	
			BA.1	Successfully boosted	
			BA.2	Successfully boosted	
			BA.2.12.1	Successfully boosted	
			BA.4/5	Successfully boosted	

<sup>a</sup> Neutralisation levels refer to ID<sub>50</sub> values against target variant. Boosting levels mean neutralisation levels to target variant were compared before and after boosting. If another vaccine is mentioned, it means that vaccine was used as a comparator. Superiority and non-inferiority mentioned here refers to pre-specified analysis as part of a clinical trial.

Superscript reference numbers: Refer to REFERENCES

usage of a nasal spray vaccine in Mexico found it to be safe and immunogenic when followed by an intramuscular dose.<sup>84</sup> Given that mucosal surfaces are often the first point of contact between SARS-CoV-2 viral particles and host cells, a strong mucosal immunity may prevent infection.<sup>40,42</sup> These mucosal vaccines may cover a gap, as some studies have indicated that the BNT162b2 vaccine does not significantly boost mucosal immunity.<sup>41</sup> This may also account for why current available vaccines are much better at preventing severe illness than infection.<sup>36,45,46</sup> Inducing strong mucosal immunity in addition to systemic immunity may provide better protection against COVID-19 infections and moderate subsequent transmission. Reducing COVID-19 transmission would better protect the unvaccinated population in the community.

These strategies for the third-generation vaccines are not mutually exclusive; mucosal vaccines still require a spike protein target<sup>42</sup> and can utilise a multivalent or even pan-sarbecovirus targeting strategy.<sup>79</sup> Furthermore, varying the administration route may provide better overall protection and warrants further investigation.<sup>84</sup> Nonetheless, a multipronged approach to the development of future COVID-19 vaccines would be important not only as COVID-19 transitions to endemicity, but also to reduce the risk of future pandemics with new emerging sarbecoviruses.

### Clinical implications of the available evidence

Drawing a firm conclusion on the optimal COVID-19 vaccine booster strategy is limited by evolving evidence and variants. The following statements reflect the authors' opinion and are in line with the Singapore Ministry of Health guidance:

1. Unvaccinated individuals should be vaccinated with any of the available licensed COVID-19 vaccines, regardless of COVID-19 infection history.
2. For individuals fully vaccinated with the primary series and first booster, who have no history of COVID-19, a second booster should be offered based on the individual's risk of severe illness. Risk factors include older age or comorbid conditions including diabetes, hypertension, chronic heart or lung disease, and active cancer. In this uninfected group, administration of bivalent vaccines that include an Omicron component (of whichever subvariant) is preferable. For individuals assessed to be at low risk, there is likely to be limited benefit from an early second booster. Annual vaccination (similar to influenza) may be optimal to re-boost the immune system after antibody waning.

3. For fully vaccinated individuals (both the primary series and first booster) who have a history of COVID-19 in the past year, protection against severe illness due to Omicron is likely to be high. In this population, early booster doses are unlikely to offer significant benefit, except in high-risk individuals, including older adults and those with immunocompromising conditions. The frequency of repeated boosters that will be required is uncertain. Again, annual vaccination may be beneficial, but in low-risk individuals, the immune effects of infection should not be ignored, and re-vaccinating one year from either last vaccine dose or infection is reasonable. This suggestion may evolve if new variants emerge with different virulence or immune evasion characteristics.

### CONCLUSION

With high levels of "hybrid" immunity from vaccination and/or prior infection among much of the world's population, rates of severe illness and death are expected to continue to decline. Nevertheless, maintaining high levels of population immunity through vaccination remains a key tool for moderating the effects of the pandemic. Current vaccine candidates that are most advanced in clinical trials (and approved in some countries like Singapore) are bivalent and multivalent vaccines targeting more than one variant at once,<sup>70,74-77</sup> and these are hoped to offer broader and sustained protection against SARS-CoV-2 infection. As the COVID-19 pandemic transitions to endemicity,<sup>85</sup> it is important that vaccine formulations as well as public health policy continue to adapt and evolve with the virus to reduce morbidity, mortality and the public health burden of this disease.

#### Disclosure

*Dr Barnaby Young reports personal fees from AstraZeneca, Gilead, Roche and Novacyt outside the scope of this work.*

#### Acknowledgements

*We would like to thank Dr Poh Xuan Ying for providing useful advice for the article.*

### REFERENCES

1. Khare S, Gurry C, Freitas L, et al. GISAID's Role in Pandemic Response. *China CDC Wkly* 2021;3:1049-51.
2. Otto SP, Day T, Arino J, et al. The origins and potential future of SARS-CoV-2 variants of concern in the evolving COVID-19 pandemic. *Curr Biol* 2021;31:R918-29.
3. Pulliam JRC, van Schalkwyk C, Govender N, et al. Increased risk of SARS-CoV-2 reinfection associated with emergence of Omicron in South Africa. *Science* 2022;376:eabn4947.



4. Ma W, Yang J, Fu H, et al. Genomic perspectives on the emerging SARS-CoV-2 omicron variant. *Genomics, Proteomics & Bioinformatics*. *Genomics Proteomics Bioinformatics* 2022;20:60-9.
5. Wolter N, Jassat W, Walaza S, et al. Early assessment of the clinical severity of the SARS-CoV-2 omicron variant in South Africa: a data linkage study. *Lancet* 2022;399:437-46.
6. Tegally H, Moir M, Everatt J, et al. Emergence of SARS-CoV-2 Omicron lineages BA.4 and BA.5 in South Africa. *Nat Med* 2022;28:1785-90.
7. Elliott P, Eales O, Steyn N, et al. Twin peaks: The Omicron SARS-CoV-2 BA.1 and BA.2 epidemics in England. *Science* 2022;376:eabq4411.
8. Fonager J, Bennedbaek M, Bager P, et al. Molecular epidemiology of the SARS-CoV-2 variant Omicron BA.2 sub-lineage in Denmark, 29 November 2021 to 2 January 2022. *Euro Surveill* 2022;27:2200181.7917.ES.2022.27.10.2200181.
9. Chemaitelly H, Ayoub HH, AlMukdad S, et al. Duration of mRNA vaccine protection against SARS-CoV-2 Omicron BA.1 and BA.2 subvariants in Qatar. *Nat Commun* 2022;13:3082.
10. Rahimi F, Talebi Bezmin Abadi A. The Omicron subvariant BA.2: Birth of a new challenge during the COVID-19 pandemic. *Int J Surg* 2022;99:106261.
11. Colson P, Delerce J, Beye M, et al. First cases of infection with the 21L/BA.2 Omicron variant in Marseille, France. *J Med Virol* 2022;94:3421-30.
12. Mohapatra RK, Kandi V, Sarangi AK, et al. The recently emerged BA.4 and BA.5 lineages of Omicron and their global health concerns amid the ongoing wave of COVID-19 pandemic – Correspondence. *Int J Surg* 2022;103:106698.
13. Yamasoba D, Kosugi Y, Kimura I, et al. Neutralisation sensitivity of SARS-CoV-2 omicron subvariants to therapeutic monoclonal antibodies. *Lancet Infect Dis* 2022;22:942-3.
14. Basky G, Vogel L. XE, XD & XF: what to know about the Omicron hybrid variants. *CMAJ* 2022;194:E654-5.
15. Rahimi F, Talebi Bezmin Abadi A. Hybrid SARS-CoV-2 variants. *Int J Surg* 2022;102:106656.
16. Mohapatra RK, Kandi V, Tuli HS, et al. The recombinant variants of SARS-CoV-2: Concerns continues amid COVID-19 pandemic. *J Med Virol* 2022;94:3506-8.
17. World Health Organization. Weekly epidemiological update on COVID-19 - 10 August 2022. <https://www.who.int/publications/m/item/weekly-epidemiological-update-on-covid-19---10-august-2022>. Accessed 17 August 2022.
18. Cao Y, Yu Y, Song W, et al. Neutralizing antibody evasion and receptor binding features of SARS-CoV-2 Omicron BA.2.75. *bioRxiv* 2022:2022.07.18.500332. doi:10.1101/2022.07.18.500332
19. Sheward DJ, Kim C, Fischbach J, et al. Evasion of neutralizing antibodies by Omicron sublineage BA.2.75. *Lancet Infect Dis* 2022;22:1421-2.
20. Bouzid D, Visseaux B, Kassassey C, et al. Comparison of Patients Infected With Delta Versus Omicron COVID-19 Variants Presenting to Paris Emergency Departments. *Ann Intern Med* 2022;175:831-7.
21. Meng B, Abdullahi A, Ferreira IATM, et al. Altered TMPRSS2 usage by SARS-CoV-2 Omicron impacts infectivity and fusogenicity. *Nature* 2022;603:706-14.
22. Du Z, Hong H, Wang S, et al. Reproduction Number of the Omicron Variant Triples That of the Delta Variant. *Viruses* 2022;14:821.
23. Lu L, Mok BWY, Chen LL, et al. Neutralization of SARS-CoV-2 Omicron variant by sera from BNT162b2 or Coronavac vaccine recipients. *Clin Infect Dis* 2022;75:e822-6.
24. Maslo C, Friedland R, Toubkin M, et al. Characteristics and Outcomes of Hospitalized Patients in South Africa During the COVID-19 Omicron Wave Compared With Previous Waves. *JAMA* 2022;327:583-4.
25. Chen C, Nadeau S, Yared M, et al. CoV-Spectrum: analysis of globally shared SARS-CoV-2 data to identify and characterize new variants. *Bioinformatics* 2021;38:1735-7.
26. Cao Y, Yisimayi A, Jian F, et al. BA.2.12.1, BA.4 and BA.5 escape antibodies elicited by Omicron infection. *Nature* 2022;608:593-602.
27. Tuekprakhon A, Nutalai R, Djokaite-Guraliuc A, et al. Antibody escape of SARS-CoV-2 Omicron BA.4 and BA.5 from vaccine and BA.1 serum. *Cell* 2022;185:2422-33.e13.
28. Khan K, Karim F, Ganga Y, et al. Omicron BA.4/BA.5 escape neutralizing immunity elicited by BA.1 infection. *Nat Commun* 2022;13:4686.
29. Keeton R, Tincho MB, Ngomti A, et al. T cell responses to SARS-CoV-2 spike cross-recognize Omicron. *Nature* 2022;603:488-92.
30. Ahmed SF, Quadeer AA, McKay MR. SARS-CoV-2 T Cell Responses Elicited by COVID-19 Vaccines or Infection Are Expected to Remain Robust against Omicron. *Viruses* 2022;14:79.
31. Guo L, Zhang Q, Zhang C, et al. Assessment of Antibody and T-Cell Responses to the SARS-CoV-2 Virus and Omicron Variant in Unvaccinated Individuals Recovered From COVID-19 Infection in Wuhan, China. *JAMA Netw Open* 2022;5:e229199.
32. Richardson SI, Madzorera VS, Spencer H, et al. SARS-CoV-2 Omicron triggers cross-reactive neutralization and Fc effector functions in previously vaccinated, but not unvaccinated, individuals. *Cell Host Microbe* 2022;30:880-6.e4.
33. Johnson AG, Amin AB, Ali AR, et al. COVID-19 Incidence and Death Rates Among Unvaccinated and Fully Vaccinated Adults with and Without Booster Doses During Periods of Delta and Omicron Variant Emergence — 25 U.S. Jurisdictions, April 4–December 25, 2021. *MMWR Morb Mortal Wkly Rep* 2022;71:132-8.
34. Birol Ilter P, Prasad S, Berkkan M, et al. Clinical severity of SARS-CoV-2 infection among vaccinated and unvaccinated pregnancies during the Omicron wave. *Ultrasound Obstet Gynecol* 2022;59:560-2.
35. Antonelli M, Pujol JC, Spector TD, et al. Risk of long COVID associated with delta versus omicron variants of SARS-CoV-2. *Lancet* 2022;399:2263-4.
36. Higdon MM, Baidya A, Walter KK, et al. Duration of effectiveness of vaccination against COVID-19 caused by the omicron variant. *Lancet Infect Dis* 2022;22:1114-6.
37. Pajon R, Doria-Rose NA, Shen X, et al. SARS-CoV-2 Omicron Variant Neutralization after mRNA-1273 Booster Vaccination. *N Engl J Med* 2022;386:1088-91.
38. Zuo F, Abolhassani H, Du L, et al. Heterologous immunization with inactivated vaccine followed by mRNA-booster elicits strong immunity against SARS-CoV-2 Omicron variant. *Nat Commun* 2022;13:2670.
39. Poh XY, Tan CW, Lee IR, et al. Antibody Response of Heterologous vs Homologous mRNA Vaccine Boosters Against the SARS-CoV-2 Omicron Variant: Interim Results from the PRIBIVAC Study, A Randomized Clinical Trial. *Clin Infect Dis* 2022:ciac345.
40. Smith N, Goncalves P, Charbit B, et al. Distinct systemic and mucosal immune responses during acute SARS-CoV-2 infection. *Nat Immunol* 2021;22:1428-39.

41. Azzi L, Dalla Gasperina D, Veronesi G, et al. Mucosal immune response in BNT162b2 COVID-19 vaccine recipients. *eBioMedicine* 2022;75:103788.
42. Alturaiki W. Considerations for Novel COVID-19 Mucosal Vaccine Development. *Vaccines* 2022;10:1173.
43. Altarawneh HN, Chemaitelly H, Ayoub HH, et al. Effects of Previous Infection and Vaccination on Symptomatic Omicron Infections. *N Engl J Med* 2022;387:21-34.
44. Collie S, Champion J, Moultrie H, et al. Effectiveness of BNT162b2 Vaccine against Omicron Variant in South Africa. *N Engl J Med* 2022;386:494-6.
45. Bar-On YM, Goldberg Y, Mandel M, et al. Protection by a Fourth Dose of BNT162b2 against Omicron in Israel. *N Engl J Med* 2022;386:1712-20.
46. Tan SHX, Cook AR, Heng D, et al. Effectiveness of BNT162b2 Vaccine against Omicron in Children 5 to 11 Years of Age. *N Engl J Med* 2022;387:525-32.
47. Zhang W, Huang L, Ye G, et al. Vaccine booster efficiently inhibits entry of SARS-CoV-2 omicron variant. *Cell Mol Immunol* 2022;19:445-6.
48. Gruell H, Vanshylla K, Tober-Lau P, et al. mRNA booster immunization elicits potent neutralizing serum activity against the SARS-CoV-2 Omicron variant. *Nat Med* 2022;28:477-80.
49. Wu M, Wall EC, Carr EJ, et al. Three-dose vaccination elicits neutralising antibodies against omicron. *Lancet* 2022;399:715-7.
50. Wang X, Zhao X, Song J, et al. Homologous or heterologous booster of inactivated vaccine reduces SARS-CoV-2 Omicron variant escape from neutralizing antibodies. *Emerg Microbes Infect* 2022;11:477-81.
51. Assawakosri S, Kanokudom S, Suntronwong N, et al. Neutralizing Activities against the Omicron Variant after a Heterologous Booster in Healthy Adults Receiving Two Doses of CoronaVac Vaccination. *J Infect Dis* 2022;226:1372-81.
52. Planas D, Saunders N, Maes P, et al. Considerable escape of SARS-CoV-2 Omicron to antibody neutralization. *Nature* 2022;602:671-5.
53. Minka SO, Minka FH. A tabulated summary of the evidence on humoral and cellular responses to the SARS-CoV-2 Omicron VOC, as well as vaccine efficacy against this variant. *Immunol Lett* 2022;243:38-43.
54. Lippi G, Mattiuzzi C, Henry BM. Neutralizing potency of COVID-19 vaccines against the SARS-CoV-2 Omicron (B.1.1.529) variant. *J Med Virol* 2022;94:1799-802.
55. Arbel R, Hammerman A, Sergienko R, et al. BNT162b2 Vaccine Booster and Mortality Due to Covid-19. *N Engl J Med* 2021;385:2413-20.
56. Zhou B, Song S, Guo H, et al. A fourth dose of Omicron RBD vaccine enhances broad neutralization against SARS-CoV-2 variants including BA.1 and BA.2 in vaccinated mice. *J Med Virol* 2022;94:3992-7.
57. Munro APS, Feng S, Janani L, et al. Safety, immunogenicity, and reactogenicity of BNT162b2 and mRNA-1273 COVID-19 vaccines given as fourth-dose boosters following two doses of ChAdOx1 nCoV-19 or BNT162b2 and a third dose of BNT162b2 (COV-BOOST): a multicentre, blinded, phase 2, randomised trial. *Lancet Infect Dis* 2022;22:1131-41.
58. Jacobson RM, Grill DE, Oberg AL, et al. Profiles of influenza A/H1N1 vaccine response using hemagglutination-inhibition titers. *Hum Vaccin Immunother* 2015;11:961-9.
59. Iwasaki A, Pillai PS. Innate immunity to influenza virus infection. *Nat Rev Immunol* 2014;14:315-28.
60. Mann JF, Acevedo R, Campo J del, et al. Delivery systems: a vaccine strategy for overcoming mucosal tolerance? *Expert Rev Vaccines* 2009;8:103-12.
61. Rose MA, Zielen S, Baumann U. Mucosal immunity and nasal influenza vaccination. *Expert Rev Vaccines* 2012;11:595-607.
62. Magen O, Waxman JG, Makov-Assif M, et al. Fourth Dose of BNT162b2 mRNA Covid-19 Vaccine in a Nationwide Setting. *N Engl J Med* 2022;386:1603-14.
63. Muhsen K, Maimon N, Mizrahi AY, et al. Association of Receipt of the Fourth BNT162b2 Dose With Omicron Infection and COVID-19 Hospitalizations Among Residents of Long-term Care Facilities. *JAMA Intern Med* 2022;182:859-67.
64. Ferdinands JM, Rao S, Dixon BE, et al. Waning 2-Dose and 3-Dose Effectiveness of mRNA Vaccines Against COVID-19–Associated Emergency Department and Urgent Care Encounters and Hospitalizations Among Adults During Periods of Delta and Omicron Variant Predominance — VISION Network, 10 States, August 2021–January 2022. *MMWR Morb Mortal Wkly Rep* 2022;71:255-63.
65. Regev-Yochay G, Gonen T, Gilboa M, et al. Efficacy of a Fourth Dose of Covid-19 mRNA Vaccine against Omicron. *N Engl J Med* 2022;386:1377-80.
66. Scobie CH. Update on SARS-CoV-2 Variants and the Epidemiology of COVID-19, 1 September 2022. <https://stacks.cdc.gov/view/cdc/120821>. Accessed 23 September 2022.
67. Arbel R, Sergienko R, Friger M, et al. Effectiveness of a second BNT162b2 booster vaccine against hospitalization and death from COVID-19 in adults aged over 60 years. *Nat Med* 2022;28:1486-90.
68. Andrews N, Stowe J, Kirsebom F, et al. Covid-19 Vaccine Effectiveness against the Omicron (B.1.1.529) Variant. *N Engl J Med* 2022;386:1532-46.
69. Gagne M, Moliva JI, Foulds KE, et al. mRNA-1273 or mRNA-Omicron boost in vaccinated macaques elicits similar B cell expansion, neutralizing responses, and protection from Omicron. *Cell* 2022;185:1556-71.e18.
70. Lee IJ, Sun CP, Wu PY, et al. Omicron-specific mRNA vaccine induced potent neutralizing antibody against Omicron but not other SARS-CoV-2 variants. *bioRxiv* 2022:2022.01.31.478406. doi:10.1101/2022.01.31.478406.
71. Qu L, Yi Z, Shen Y, et al. Circular RNA vaccines against SARS-CoV-2 and emerging variants. *Cell* 2022;185:1728-44.e16.
72. Zang J, Zhang C, Yin Y, et al. An mRNA vaccine candidate for the SARS-CoV-2 Omicron variant. *bioRxiv* 2022:2022.02.07.479348.
73. Du P, Li N, Xiong X, et al. A bivalent vaccine containing D614G and BA.1 spike trimer proteins or a BA.1 spike trimer protein booster shows broad neutralizing immunity. *J Med Virol* 2022;94:4287-93.
74. Zhang Y, Tan W, Lou Z, et al. Immunogenicity Evaluating of the Multivalent COVID-19 Inactivated Vaccine against the SARS-CoV-2 Variants. *Vaccines*. 2022;10:956.

75. González-Domínguez I, Martínez JL, Slamanig S, et al. Trivalent NDV-HXP-S Vaccine Protects against Phylogenetically Distant SARS-CoV-2 Variants of Concern in Mice. *Microbiol Spectr* 2022;10:e0153822.
  76. Chalkias S, Harper C, Vrbicky K, et al. A Bivalent Omicron-containing Booster Vaccine Against Covid-19. *N Engl J Med* 2022;387:1279-91.
  77. Chalkias S, Eder F, Essink B, et al. Safety, Immunogenicity and Antibody Persistence of a Bivalent Beta-Containing Booster Vaccine against COVID-19: A Phase 2/3 Trial. *Nat Med* 2022;28:2388-97. *Nat Med* 2022.
  78. Swanson, K. Pfizer/BioNTech COVID-19 Omicron-modified bivalent vaccine, 1 September 2022. [https:// stacks.cdc.gov/view/ cdc/120826](https://stacks.cdc.gov/view/cdc/120826). Accessed 23 September 2022.
  79. Tan CW, Chia WN, Young BE, et al. Pan-Sarbecovirus Neutralizing Antibodies in BNT162b2-Immunized SARS-CoV-1 Survivors. *N Engl J Med* 2021;385:1401-6.
  80. Calzas C, Chevalier C. Innovative Mucosal Vaccine Formulations Against Influenza A Virus Infections. *Frontiers in Immunology*. *Front Immunol* 2019;10:1605.
  81. Xi J, Lei LR, Zouzas W, et al. Nasally inhaled therapeutics and vaccination for COVID-19: Developments and challenges. *MedComm* 2021;2:569-86.
  82. Heida R, Hinrichs WL, Frijlink HW. Inhaled vaccine delivery in the combat against respiratory viruses: a 2021 overview of recent developments and implications for COVID-19. *Expert Rev Vaccines* 2022;21:957-74.
  83. Alu A, Chen L, Lei H, et al. Intranasal COVID-19 vaccines: From bench to bed. *eBioMedicine* 2022;76:103841.
  84. Ponce-de-León S, Torres M, Soto-Ramírez LE, et al. Safety and immunogenicity of a live recombinant Newcastle disease virus-based COVID-19 vaccine (Patria) administered via the intramuscular or intranasal route: Interim results of a non-randomized open label phase I trial in Mexico. *medRxiv* 2022:2022.02.08.22270676. doi:10.1101/2022.02.08.22270676.
  85. Wei WE, Tan WK, Cook AR, et al. Living with COVID-19: The road ahead. *Ann Acad Med Singap* 2021;50:619-28.
-

## ‘Roe’ling with the punches: Telehealth contraception and abortion

Soe-Na Choo<sup>1</sup> *Mb Bch BaO*, Judith Ong<sup>1</sup> *MBBS*

Unsafe abortion is a global health issue as it is a key preventable cause of maternal mortality. It has been estimated that up to 13% of maternal deaths per year are due to unsafe abortions.<sup>1</sup> Women in developing countries make up 97% of all unsafe abortions and more than 50% of unsafe abortions occur in conservative societies in Asia and Africa.<sup>2</sup> Fortunately, maternal mortality has been steadily decreasing, which can be attributed to several factors. One is the legalisation and normalisation of abortion, whereby access to safe abortion services and contraception reduces maternal mortality.<sup>2</sup> In 1996, when abortion was legalised in South Africa and safe abortion services established, maternal mortality dramatically dropped from an estimated 425 deaths per 1,000 abortions before the legislation to 32 deaths per 1,000 abortions in 1998.<sup>3</sup>

Abortion in Singapore has been legal since 1970, with the abortion act of 1969 instituted to protect women against the dangers of illegal abortions.<sup>4</sup> According to the Termination of Pregnancy Act, there is no defined minimum or maximum age for the abortion procedure in Singapore and there is no legal requirement for parental consent for minors (under 16 years of age). Abortion is prohibited after 24 weeks of pregnancy unless the mother’s life is in danger.<sup>5</sup> At present, abortion care is easily accessible and available in both public and private hospitals. While there have been occasional calls for a reduction in access to abortion services, the Association of Women for Action and Research, a Singapore women’s rights and gender equality advocacy group, has strongly advocated for abortion care.

*Roe v Wade* was a landmark ruling of the US Supreme Court in 1973, which led to legalisation of abortion across all its states.<sup>6</sup> In June 2022 however, the Supreme Court ruled in favour of Mississippi’s ban on abortions after 15 weeks of pregnancy, allowing states to ban abortions again.<sup>7</sup> Subsequently, access to abortions in medical clinics has been dwindling, with evidence showing that Americans have been performing self-abortions and abortions outside the medical setting.<sup>7</sup> Self-managed abortions are not new, dating back centuries

involving physical and non-physical methods such as botanicals, and later misoprostol. An evolving concept of self-managed abortions in a safer environment is the use of online telemedicine to provide abortion medications to women seeking an abortion.<sup>8</sup> This contemporary method of medical abortions via telemedicine has been offered since 2008,<sup>9</sup> but has drawn greater attention recently due to the COVID-19 pandemic,<sup>10</sup> and with the permanent allowance of mail-order abortion pills approved by the US Food and Drug Administration (FDA) in 2020.

Considering the recent proceedings in the US Supreme Court, there is warranted concern that maternal morbidity and mortality attributed to unsafe abortions will increase as access to abortions in medical clinics becomes restricted. However, if mail-to-order abortion pills remain available, this potentially could provide a safe alternative.

### Implications of banned abortions

When obstacles to abortion exist, women usually find ways to circumvent the law. Prior to 2019, Ireland possessed one of the most restrictive abortion laws in the world, much like the circumstances in South Africa in the early 1990s. This resulted in maternal mortalities due to complications surrounding delayed medical termination. In addition, travelling across the border for an abortion became commonplace. For example, Mexico City in Mexico is the only state where abortion is available on request in the country, while in Chile, women travel to a Peruvian city where abortions are legal.<sup>2</sup> However, factoring in the additional cost of travel, travel experience and subsequent post-abortion care, women struggling financially become disadvantaged. An alternative cheaper method to avoid the abortion laws would then be procuring abortifacient medications via informal networks. With non-approved prescribed abortifacient medications and lack of post-abortion care, it is not surprising that unsafe abortions with related maternal mortality occur in developing countries or to those who are socially disadvantaged.

With more restrictive abortion legislation, changes in the number of abortions and maternal deaths are

<sup>1</sup> Department of Obstetrics and Gynaecology, National University Hospital, Singapore

Correspondence: Dr Soe-Na Choo, Department of Obstetrics and Gynaecology, National University Hospital, 5 Lower Kent Ridge Rd, Singapore 119074.  
Email: soe\_na\_choo@nuhs.edu.sg



most concerning. For instance, Romania implemented a more restrictive abortion law in 1966. The number of abortion-related deaths climbed rapidly from 20 per 100,000 livebirths in 1965 to almost 100 in 1974, and 150 in 1983. When abortions were legalised again in December 1989, the abortion-related maternal mortality fell by 67% in the first year to approximately 60 per 100,000 livebirths.<sup>11</sup>

### **Safety of telehealth and mail-order abortions**

Anxiety around potentially reduced access to in-clinic abortions due to alterations in legislation could shift abortion to telemedicine and mail-order abortion pills. In 2021, FDA permitted access to abortion pills via mail. As a large proportion of early abortions are performed medically,<sup>12</sup> it is only prudent to evaluate the safety profile of telehealth and mail-order abortions. Medical abortions with mifepristone and misoprostol are an established safe option for the termination of pregnancies. Success rates reach 99% with more than 95% of women successfully ending their pregnancy without surgical intervention. The large body of evidence around medical abortions displays adversity secondary to abortifacient medications to be minimal.

Specifically for mail-to-order abortion, a study in US revealed that 99% of women were satisfied with this method.<sup>13</sup> When comparing abortions provided through telemedicine versus in-person consultations, there were no differences in adverse outcomes.<sup>8,9,13</sup> This is further substantiated by the UK Royal College of Obstetrics and Gynaecology, which has supported gestational age calculation of a pregnancy based on the woman's last menstrual period for telemedicine abortions up until 10 weeks' gestation, without the need for pre-abortion ultrasound assessments.<sup>14</sup> A study in Scotland exhibited high rates of complete abortion accompanied by low rates of complications and unscheduled medical contact.<sup>15</sup> As recommended by the World Health Organization (WHO), if the necessity of a pre-abortion ultrasound is negated, this potentially expands the range of healthcare providers offering medical abortion and thus post-abortion care. Perhaps more importantly, telehealth abortions have been found to be more affordable,<sup>16</sup> potentially targeting families suffering from financial hardships and who are at risk of not seeking conventional medical care, and maternal mortality. A study in the UK discovered that early medical abortions routinely performed at home through telemedicine could lead to healthcare savings of GBP3 million per year.<sup>17</sup> The mere convenience of this method has resulted in its high patient satisfaction rates. The

advantages of telehealth are multifold in terms of safety, convenience and affordability.

Given the comparable efficacy, safety and patient satisfaction rates, mail-to-order abortion should be an alternative option. Advantages from an individual perspective include privacy as the women can have an abortion in the anonymity of their own home. From a cost-effectiveness standpoint, the ability to omit a pre-abortion ultrasound can save healthcare costs and time.<sup>17</sup> Lastly, in the context of the pandemic, having mail-order abortions ensures there is equity of abortion care for all who need it globally even in more remote areas.

It must be recognised that mail-order abortions currently remain safe for first-trimester abortions. Therefore, the limitation of this method is that from the second trimester onwards, mail-order abortions as an option will no longer exist and patients will require inpatient medical care. In addition, managing post-abortion care from home hinges on a reliable telephone, internet connectivity or a fixed home mailing address, and not all who prefer home abortions will have access to or be able to seek help should there be any post-abortion complications.<sup>18</sup> Patients who had not done pre-abortion ultrasounds were however more likely to seek post-treatment care and opt for procedural interventions including dilation and curettage, although there was no difference in rates of hospitalisation, ongoing pregnancies or blood transfusions.<sup>19</sup> Safety nets around sexual assaults and sexually transmitted infections should also ideally be assessed prior to individuals obtaining abortion pills. These additional vulnerabilities may be more common in women seeking telemedicine or telehealth due to stigmatisation.<sup>20</sup> In the Singapore context, given its small geographic size, healthcare accessibility is less of an issue.

### **Contraceptive awareness**

Primary prevention of unwanted pregnancies is important, and awareness of reliable contraception should be raised. The improvement in maternal mortality secondary to abortions is not merely due to legislation around abortion, but in part due to family-planning initiatives that reduce the incidence of unwanted pregnancies, and access to medical care in life-threatening situations.<sup>2</sup> In the US, women living in states with low abortion access were more likely to use highly effective contraception if this was available (relative risk ratio 1.4). Time-sensitive emergency contraception including ulipristal acetate is available over the counter in certain countries. There is rising concern that along with more restrictive abortion laws,

the availability of contraception may change. Perhaps the scope of telemedicine should be extended to contraception counselling and provision, to further increase affordability and accessibility.

### Conclusion

An estimated 56 million abortions occur globally per year, with up to 25% of pregnancies ending in abortions.<sup>2</sup> When unsafe abortions are a preventable cause of maternal mortality, the morbidity and mortality surrounding unsafe abortions highlight social inequity. The significance is underscored by WHO, which defines reproductive health as not only the ability to reproduce, but also the freedom to decide if, when and how often to do so.<sup>21</sup> Given the stark differences between the political landscape in the US and Singapore, the overturning of *Roe v Wade* is unlikely to significantly change the abortion legislation or care in Singapore. With the greater establishment of telemedicine during the COVID-19 pandemic specifically for mail-to-order abortion pills, this could offer a cost-effective and safe alternative to providing healthcare in the future. Vulnerabilities around sexually transmitted infections and sexual assault may be challenging to ascertain through telemedicine, but its use could potentially be a promising option for the provision of care to women of all demographics and socioeconomic status seeking contraception and mail-order abortions.

### REFERENCES

- World Health Organization. Abortion, 25 November 2021. <https://www.who.int/news-room/fact-sheets/detail/abortion>. Accessed 20 June 2022
- Guillaume, Agnès, Clémentine Rossier. L'avortement dans le monde. État des lieux des législations, mesures, tendances et conséquences. *Population* 2018;73:225-322.
- Jewkes R, Rees H. Dramatic decline in abortion mortality due to the Choice on Termination of Pregnancy Act. *S Afr Med J* 2005;95:250.
- Chen AJ, Emmanuel SC, Ling SL, et al. Legalized abortion: the Singapore experience. *Stud Fam Plann* 1985;16:170-8.
- Singapore Statutes Online. Termination of Pregnancy Act 1974, revised 2020. <https://sso.agc.gov.sg/Act/Tpa1974>. Accessed 20 August 2022.
- Roe v Wade*, 410 U.S 113 (1973).
- Dobbs v Jackson Women's Health Organization*, 597 U.S. (2022).
- Aiken ARA, Romanova EP, Morber JR, et al. Safety and effectiveness of self-managed medication abortion provided using online telemedicine in the United States: A population based study. *Lancet Reg Health Am* 2022;10:100200.
- Grossman D, Grindlay K. Safety of Medical Abortion Provided Through Telemedicine Compared With In Person. *Obstet Gynecol* 2017;130:778-82.
- Aiken ARA, Starling JE, Gomperts R, et al. Demand for Self-Managed Online Telemedicine Abortion in the United States During the Coronavirus Disease 2019 (COVID-19) Pandemic. *Obstet Gynecol* 2020;136:835-7.
- Singh K, Ratnam SS. The influence of abortion legislation on maternal mortality. *Int J Gynaecol Obstet* 1998;63(Suppl 1):S123-9.
- Kortsmit K, Mandel MG, Reeves JA, et al. Abortion Surveillance — United States, 2019. *MMWR Surveill Summ* 2021;70:1-29.
- Chong E, Shochet T, Raymond E, et al. Expansion of a direct-to-patient telemedicine abortion service in the United States and experience during the COVID-19 pandemic. *Contraception*. 2021;104:43-48.
- Royal College of Obstetricians and Gynaecologists. Coronavirus (COVID-19) infection and abortion care, 31 July 2020. <https://www.rcog.org.uk/en/guidelines-research-services/guidelines/coronavirus-abortion/>. Accessed 19 November 2022.
- Reynolds-Wright JJ, Johnstone A, McCabe K, et al. Telemedicine medical abortion at home under 12 weeks' gestation: a prospective observational cohort study during the COVID-19 pandemic. *BMJ Sex Reprod Health* 2021;47:246-51.
- Johnson DM, Madera M, Gomperts R, et al. The economic context of pursuing online medication abortion in the United States. *SSM Qual Res Health* 2021;1:100003.
- Hawkins JE, Glasier A, Hall S, et al. RCOG Telemedicine cost-effectiveness working group. Early medical abortion by telemedicine in the United Kingdom: a costing analysis. *BJOG* 2022;129:969-75.
- Mark A, Foster AM, Perritt J. The future of abortion is now: Mifepristone by mail and in-clinic abortion access in the United States. *Contraception* 2021;104:38-42.
- Anger HA, Raymond EG, Grant M, et al. Clinical and service delivery implications of omitting ultrasound before medication abortion provided via direct-to-patient telemedicine and mail in the U.S. *Contraception* 2021;104:659-65.
- Bosó Pérez R, Reid D, Maxwell KJ, et al. Access to and quality of sexual and reproductive health services in Britain during the early stages of the COVID-19 pandemic: a qualitative interview study of patient experiences. *BMJ Sex Reprod Health* 2022. doi: 10.1136/bmjsex-2021-201413.
- World Health Organization. Reproductive Health. <https://www.who.int/southeastasia/health-topics/reproductive-health>. Accessed 19 November 2022.

## Self-sampling HPV DNA test for cervical cancer screening in Singapore: A prospective study

### Dear Editor,

Cervical cancer is known to be the most preventable malignancy through both vaccination and screening. However, it remains the tenth most common cancer among women in Singapore. Cervical cancer screening is opportunistic in Singapore and only 1 in 2 women undergo regular screening in Singapore.<sup>1</sup> Under-screened women are at the highest risk of cervical cancer, and reasons for poor compliance include fear, discomfort and a busy schedule.<sup>2</sup> The superiority of human papillomavirus (HPV) DNA test compared to cytology screening in detecting pre-invasive cervical disease has been well-established due to its higher sensitivity,<sup>3,4</sup> resulting in the shift to HPV primary screening in Singapore in 2019.<sup>5</sup> The self-sampling method of HPV testing has been mooted as a potential strategy to address the issue of poor compliance to cervical cancer screening. International studies have shown a high level of concordance between self- and physician-sampling for the detection of HPV DNA,<sup>6,7</sup> with strong evidence for women's acceptability for self-sampling.<sup>8</sup>

The primary aim of the study is to establish the acceptability of self-sampling for cervical cancer screening among women attending gynaecological care at a tertiary hospital. Our secondary aim is to compare the concordance between the self-sampling and physician-sampling methods. To our knowledge, there has been no study on HPV self-screening in Singapore. This study would have a considerable impact on future national screening policies that could increase cervical cancer screening uptake by introducing an accessible method to the under-screened population in Singapore.

This was a prospective, randomised crossover study of 300 women attending gynaecology clinics in National University Hospital, Singapore, carried out from April 2019 to September 2020 (online Supplementary Fig. S1). Ethical approval had been obtained from the Domain Specific Review Board (Reference: 2018/00846-SRF0002). The study was registered with ClinicalTrials.gov (identifier: NCT03813576). The inclusion criteria were all women aged 30–69 years who were scheduled to attend cervical screening. The exclusion criteria were women who are pregnant,

with previous total hysterectomy, previous history of cervical cancer, currently menstruating, virgo intactas and women with recent negative cervical cancer screening. We utilised a crossover trial design. Participants were randomised into 2 groups in a 1:1 ratio, with the first arm undergoing the HPV self-sampling before physician-sampling and the second arm in the reverse sequence. All self-sampling and physician-collected swabs were processed using the Cobas 6800 HPV assay (Roche Diagnostics International AG, Rotkreuz, Switzerland). After their experience, participants completed a questionnaire to assess their acceptability of self-sampling. The participants' clinical management was not affected by the study.

The sample size was calculated based on the number of women aged 30–69 in Singapore's population (as of June 2017), using G\*Power. All data were analysed using SPSS version 20.0 (SPSS Inc, Chicago, US). Descriptive analyses were done on the survey data, while the agreement of self- and physician-collected specimens were assessed using Cohen's kappa ( $\kappa$ ). The 95% confidence interval (CI) was estimated for  $\kappa$ . We also calculated sensitivity and specificity with 95% CIs between the 2 sampling methods.

Table 1 summarises the participants' preferences regarding the type of HPV sampling method, as well as the performance of HPV self-sampling method in cervical cancer screening. The majority of participants found self-sampling easy to perform (79%) with only minimal discomfort (89%). Most participants preferred self-sampling (84%) over physician-sampling (13%), and among those who preferred self-sampling, 86% expressed that they would prefer to perform the self-sampling at home rather than a clinic (14%). If given the option of self-sampling in the future, 90% expressed that they were more likely to participate in cervical cancer screening. About half of the participants also expressed willingness to pay for the self-sampling swab (51%).

A total of 60/300 (20.0%) self-collected samples and 63/300 (21.0%) of physician-collected samples tested positive for high-risk HPV. Two hundred and seventy-seven (92.3%) of 300 self-sampling test results were in

Table 1. Study participants preferences regarding the 2 sampling collection methods and the performance of human papillomavirus self-sampling method in cervical cancer screening

	<b>Yes No. (%)</b>	<b>No No. (%)</b>	<b>Not sure No. (%)</b>		
Do you think that cervical cancer screening is valuable?	286 (95.3)	6 (2.0)	8 (2.7)		
Have you had any cervical cancer vaccinations?	41 (13.7)	236 (78.7)	23 (7.7)		
Have you ever had a PAP test?	287 (95.7)	12 (4.0)	1 (0.3)		
Have you ever used tampons?	93 (31.0)	207 (69)	0 (0)		
Have you ever smoked?	58 (19.3)	242 (80.7)	0 (0)		
<b>Patient experience on HPV self-sampling</b>					
	<b>Strongly disagree No. (%)</b>	<b>Disagree No. (%)</b>	<b>Neutral No. (%)</b>	<b>Agree No. (%)</b>	<b>Strongly agree No. (%)</b>
Did you find it difficult to conduct?	3 (1.0)	11 (3.7)	50 (16.7)	104 (34.7)	132 (44.0)
Did you find the process uncomfortable?	194 (64.7)	74 (24.7)	22 (7.3)	4 (1.3)	6 (2.0)
Did you feel anxious during the procedure?	83 (27.7)	35 (11.7)	99 (33.0)	18 (6.0)	6 (2.0)
Did you feel embarrassed during the procedure?	NA	157 (52.3)	68 (22.7)	16 (5.3)	NA
Did you find the process unpleasant?	141 (47.0)	19 (6.3)	66 (22.0)	12 (4.0)	3 (1.0)
<b>Patient preferences on future cervical cancer screening</b>					
	<b>Self-sampling at home No. (%)</b>	<b>Self-sampling at health centre No. (%)</b>	<b>Physician- sampling No. (%)</b>	<b>Does not matter No. (%)</b>	
Where and how would you prefer to conduct your cervical cancer screening?	217 (72.3%)	36 (12.0%)	39 (13.0%)	8 (2.7%)	
	<b>Yes No. (%)</b>	<b>No No. (%)</b>	<b>Not sure No. (%)</b>		
Are you likely to participate in future cervical cancer screening if you have the option of self-sampling?	271 (90.3)	29 (9.7)	0		
Would you be willing to pay for cervical cancer screening by self-sampling?	153 (51.0)	88 (29.3)	59 (19.7)		
<b>Performance of HPV self-sampling method in cervical cancer screening</b>					
	<b>Value (%)</b>	<b>95% confidence interval</b>			
Specificity	94.6	90.9–97.1			
Sensitivity	83.3	71.5–91.7			
Positive predictive value	79.4	69.1–86.9			
Negative predictive value	95.8	92.8–97.6			
Accuracy	93.3	88.7–95.1			
Cohen's kappa, $\kappa$	0.77, $P < 0.001$	0.67–0.86			

HPV: human papillomavirus; NA: not applicable



concordance with the physician-collected samples, with discordant results observed in only 23 samples (7.7%). The sensitivity and specificity of the self-sampling tests were 83.3% (95% CI, 71.5–91.7) and 94.6% (95% CI 90.9–97.1), respectively. Concordance analysis engendered a kappa of 0.77 (95% CI 0.67–0.86,  $P < 0.001$ ), presenting a substantial agreement between the results of the physician-collected and self-collected samples.

From our study, it was evident the acceptability of the self-sampling swab by the participants was high as the majority found it easy to perform with minimal discomfort, anxiety and embarrassment. Our study also showed substantial agreement between the results from the self-sampling and physician-sampling tests, as corroborated by international meta-analysis.

HPV self-sampling is a potential intervention that can increase cervical cancer screening uptake by overcoming barriers such as fear, discomfort and the inconvenience of visiting a health centre for screening. A randomised clinical trial conducted in the US targeting the under-screened population showed that mailing HPV kits increased screening uptake compared to usual care reminders for in-clinic screening.<sup>9</sup> This was also reflected in our study where the women were more likely to participate in screening if the self-sampling method was available. The next step moving forward would be to assess the acceptability of HPV self-sampling among women in the community setting.

In view of its high efficacy and acceptability, countries such as Australia and the Netherlands have incorporated HPV self-sampling into their national screening programmes in a move to increase screening uptake. Results from our study are encouraging, and this could pave the way for Singapore to incorporate self-sampling into the national screening programme. Increasing screening uptake is one of the 3-pronged approaches identified by the World Health Organization to achieve the ultimate goal of eradicating cervical cancer.<sup>10</sup> It is our hope that incorporating a self-sampling test would help us move closer to that goal.

#### Acknowledgements

We would like to thank Dr Ida Ismail-Pratt for her invaluable guidance for this study, and Ms Wan Sin Yee Carrie for assisting with the data collection and study administration.

#### REFERENCES

1. Singapore Cancer Registry, Health Promotion Board. Singapore Cancer Registry Annual Report 2019, 28 January 2022. [https://www.nrdo.gov.sg/docs/librariesprovider3/default-document-library/scr-2019\\_annual-report\\_final.pdf?sfvrsn=fa847590\\_0](https://www.nrdo.gov.sg/docs/librariesprovider3/default-document-library/scr-2019_annual-report_final.pdf?sfvrsn=fa847590_0). Accessed 22 April 2022.
2. Sultana F, Mullins R, English DR, et al. Women's experience with home-based self-sampling for human papillomavirus testing. *BMC Cancer* 2015;15.
3. Whitlock EP, Vesco KK, Eder M, et al. Liquid-based cytology and human papillomavirus testing to screen for cervical cancer: a systematic review for the U.S. Preventive Services Task Force. *Ann Intern Med* 2011;155:687-97, W214-5.
4. Ronco G, Dillner J, Elfström KM, et al. Efficacy of HPV-based screening for prevention of invasive cervical cancer: follow-up of four European randomised controlled trials. *Lancet* 2014;383:524-32.
5. Cervical Screen Singapore Advisory Committee. Management Guidelines for Cervical Screening and Preinvasive Disease of the Cervix, February 2019. [https://www.sccps.org/wp-content/uploads/2019/03/CSS-Clinical-Mgt-Guidelines-2019\\_March-Release.pdf](https://www.sccps.org/wp-content/uploads/2019/03/CSS-Clinical-Mgt-Guidelines-2019_March-Release.pdf). Accessed 22 April 2019.
6. Arbyn M, Verdoodt F, Snijders PJF et al. Accuracy of human papillomavirus testing on self-collected versus clinician-collected samples: a meta-analysis. *Lancet Oncol* 2014;15:172-83.
7. Petignat P, Faltin DL, Bruchim I, et al. Are self-collected samples comparable to physician-collected cervical specimens for human papillomavirus DNA testing? A systematic review and meta-analysis. *Gynecol Oncol* 2007;105:530-5.
8. Ma'som M, Bhoo-Pathy N, Nasir NH et al. Attitudes and factors affecting acceptability of self-administered cervicovaginal sampling for human papillomavirus (HPV) genotyping as an alternative to Pap testing among multiethnic Malaysian women. *BMJ Open* 2016;6:e011022.
9. Winer RL, Lin J, Tiro JA, et al. Effect of Mailed Human Papillomavirus Test Kits vs Usual Care Reminders on Cervical Cancer Screening Uptake, Precancer Detection, and Treatment: A Randomized Clinical Trial. *JAMA Netw Open* 2019;2:e1914729.
10. Adanu RMK. Eradicating cervical cancer. *Int J Gynaecol Obstet* 2020;148:1-2.

Li Min Lim<sup>1</sup>*MRCOG*, Ming Fen Grace Chan<sup>1</sup>*MBBS*,  
Pa Pa Thu Win<sup>1</sup>*MBBS*, Liang Shen<sup>2</sup>*PhD*,  
Ilancheran Arunachalam<sup>1</sup>*FRCOG*,  
Soon Yau Joseph Ng<sup>1</sup>*FACOG*, Jen Hui Jeffrey Low<sup>1</sup>*FRCOG*

<sup>1</sup>Department of Obstetrics and Gynaecology, National University Hospital, Singapore

<sup>2</sup>Biostatistics Unit, Yong Loo Lin School of Medicine, National University of Singapore, Singapore

Correspondence: Dr Li Min Lim, Department of Obstetrics and Gynaecology, National University Hospital, 5 Lower Kent Ridge Road, Singapore 119074.

Email: li\_min\_lim@nuhs.edu.sg

## Early rehabilitation to improve functional outcomes in childhood cancer in Singapore

### Dear Editor,

We conducted a prospective, single-centre cohort study to review the impact of a multidisciplinary rehabilitation programme in children with cancer in Singapore. The Template for Intervention Description and Replication (TIDieR) checklist was used to allow sufficient details for replication of the study (see Appendix in online Supplementary Material).<sup>1</sup> The study was funded by Children's Cancer Foundation, a Singapore charity.

In Singapore, there were 720 cases of childhood cancer (below 19 years) between 2013 and 2017, with an incidence rate of 17 per 100,000 population.<sup>2</sup> With the advent of targeted medical therapy, childhood cancer survivorship has been reported at 80% in Singapore.<sup>3</sup> Along with the improved survival rate, the long-term side effects of cancer treatment—for instance, reduced physical functioning, self-esteem and quality of life<sup>4-6</sup>—are becoming all the more pertinent to understanding the true burden of the disease.<sup>4</sup>

There are limited studies exploring the impact of a multidisciplinary approach on functional outcomes in children with cancer in the acute setting. A 2-week intensive multidisciplinary programme in the acute setting found significant gains in function with no adverse effects.<sup>7</sup> A scoping review of 12 studies supports the feasibility of physiotherapy intervention for childhood cancer; however, the current evidence is not yet at a level to inform clinical practice.<sup>8</sup>

We recruited Singapore citizens and permanent residents, aged 2 to 17 years, who were newly diagnosed with cancer from March 2017 through November 2020. Children with relapsed cancer were excluded. As part of this new programme, baseline functional status was assessed one working day after their confirmed diagnosis. This contrasted with the usual practice of a physician-directed referral for rehabilitation only when a deficit was noticed. The assessments were conducted by registered allied health professionals (for example, physiotherapists) accredited to administer the Functional Independence Measure for Children (WeeFIM), and the Goal Attainment Scale (GAS). The WeeFIM and GAS were subsequently repeated at 3, 6, 9 and 12 months. Following the baseline assessment, children participated in an individualised programme based on their needs. This included one or more of the following: music, occupational, physio-

and speech therapy. The aim of therapy was to return children to their premorbid status and address any developmental delay or impairment. The interventions were conducted in person by the respective disciplines either in the inpatient or outpatient setting, with each session lasting about 45 minutes. The frequency of interventions ranged from daily to weekly. Functional impairments were identified at the baseline assessment and reviewed at the follow-up time points; therapy was adjusted as required. In children assessed to have no deficits, and rehabilitation deemed unnecessary, caregivers were advised to monitor their functional ability and self-refer for rehabilitation if required later.

Patient safety was a priority, especially during the acute phase of cancer treatment. The patient's clinical status was evaluated prior to each session, and parameters such as haemoglobin and platelet level were taken into consideration. Interventions were thus adjusted to account for the side effects of cancer treatment.

Statistical analysis was conducted on the 4 domains of WeeFIM—self-care, mobility, cognition and overall function. Three-way mixed analysis of variance (2 x 3 x 5 mixed analysis of variance) was used to analyse the data. The independent variables included sex, diagnosis (blood cancer, solid tumour or brain tumour), and time (0, 3, 6, 9 and 12 months). A frequency analysis was done to observe common types of GAS for this population and the rate of achievement of these goals.

There were 91 children recruited into the study who were assessed at baseline for functional impairment. Of this number, only 34 children consisting of 21 boys and 13 girls required intervention. The mean age was 9.13 years (standard deviation = 4.73). The distribution of cancer diagnoses was 14 solid tumour cases, 11 blood cancer cases and 9 brain tumour cases.

There was a significant main effect of time (from baseline) on domains of self-care ( $F(2.03, 56.36) = 14.70, P < 0.01$ ), mobility ( $F(2.51, 70.15) = 12.97, P < 0.01$ ), and total functioning score ( $F(2.03, 56.94) = 11.12, P < 0.01$ ). There was, however, no significant main effect of time on cognition ( $F(1.05, 29.40) = 1.93, P = 0.18$ ). The mean values showed progressive linear improvement, except for cognition. This non-effect on cognition is not surprising as the majority were not brain tumours.

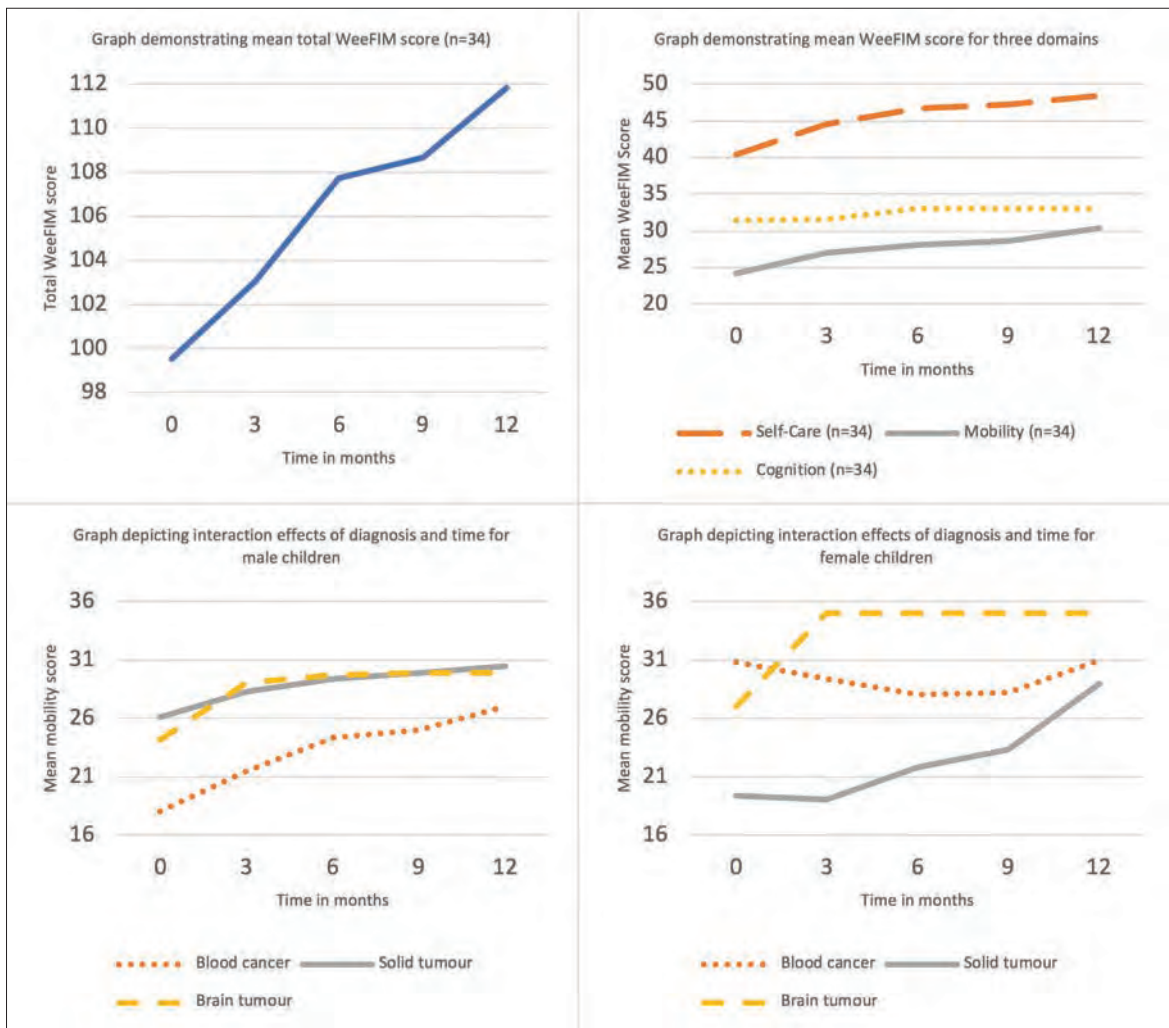

Fig. 1. Graph depicting the Functional Independence Measure for Children (WeeFIM) results.

Lastly, sex differences on mobility scores were noted when the interaction between time and type of diagnosis were considered ( $F(5.01, 70.15) = 2.76, P=0.03$ ). The trends can be seen in Fig. 1.

WeeFIM was primarily developed as a measure of disability rather than function. Despite its original intent, we were able to demonstrate a change in total score after the programme. The significant sex effect on mobility scores might be explained by sex differences: a systematic review found that males were more successful in their gross motor skills.<sup>9</sup>

A total of 155 GAS were formulated and mapped to domains of the World Health Organization International Classification Framework to classify the types of goals that were set. A total of 56 goals (36.1%) were under the domain of Body Functions and Impairments, 98 goals (63.2%) under the domain of Activity and Participation and 1 goal (0.6%) under the Environmental domain.

A high number of 142 (91.6%) goals were met or exceeded. Only 13 (8.4%) goals were not met and 11 of these were from the Activity and Participation domain. Upon analysis, one of the main reasons they were not achieved was due to complications during cancer treatment, such as stroke.

Improving functional ability in children translates to an increase in physical activity, participation and quality of life.<sup>10</sup> Our study did not uncover any adverse events and supports the safety and efficacy of rehabilitation in the acute phase of cancer. Although improvements in functional ability were found, interpretation of results should be taken with caution as there was no control group. Despite a long recruitment period, the rare nature of childhood cancer limits the sample size. Future multicentre studies will hopefully strengthen the evidence base and expand the body of literature regarding paediatric oncologic rehabilitation.

### Acknowledgements

The authors would like to acknowledge Julia Xue and Amanda Siew for their contribution towards the research and Singapore Children's Cancer Foundation for their funding support.

### REFERENCES

- Hoffmann T, Glasziou P, Boutron I, et al. Better reporting of interventions: template for intervention description and replication (TIDieR) checklist and guide. *BMJ* 2014;348:g1687.
- Health Promotion Board. Singapore Cancer Registry Anniversary Monograph 1968 -2017. [https://www.nrdo.gov.sg/docs/librariesprovider3/default-document-library/thespore-cancerregistry\\_commerativebook\\_-1.pdf?sfvrsn=231fce6e\\_0](https://www.nrdo.gov.sg/docs/librariesprovider3/default-document-library/thespore-cancerregistry_commerativebook_-1.pdf?sfvrsn=231fce6e_0). Accessed 11 July 2020.
- Allemani C, Matsuda T, Di Carlo V, et al. Global surveillance of trends in cancer survival 2000–14 (CONCORD-3): analysis of individual records for 37 513 025 patients diagnosed with one of 18 cancers from 322 population-based registries in 71 countries. *Lancet* 2018;391:1023-75.
- Kruijssen-Jaarsma M, Révész D, Bierings MB, et al. Effects of exercise on immune function in patients with cancer: A systematic review. *Exerc Immunol Rev* 2013;19:120-43.
- Wacker K, Tanner L, Ovans J, et al. Improving Functional Mobility in Children and Adolescents Undergoing Treatment for Non-Central Nervous System Cancers: A Systematic Review. *PM R* 2017;9:S385-97.
- Pek JH, Chan YH, Yeoh AEJ, et al. Health-related Quality of Life in Children with Cancer Undergoing Treatment: A First Look at the Singapore Experience. *Ann Acad Med Singap* 2010;39:43-8.
- Tsao E, Flanigan M, Johnson L, et al. Functional outcomes of pediatric patients in Short-term Pediatric Rehabilitation Intensive Therapy (SPRINT) while receiving acute oncologic and hematologic care. *PM R* 2022;14:357-65.
- Ospina PA, McNeely ML. A Scoping Review of Physical Therapy Interventions for Childhood Cancers. *Physiother Can* 2019 Summer;71:287-96.
- Rodrigues P, Ribeiro M, Barros R, et al. Performance on the movement assessment battery for children: A systematic review about gender differences. *Rev Int de Cienc Deporte* 2019;15:72-87.
- Grilli L, Feldman DE, Majnemer A, et al. Associations between a Functional Independence Measure (WeeFIM) and the Pediatric Quality of Life Inventory (PedsQL4.0) in Young Children with Physical Disabilities. *Qual Life Res* 2006;15:1023-31.

Lindsey Weller <sup>1</sup>*MPH*, Kayla Wong <sup>2</sup>*MMusTherpy*,  
Ce Yu Foo <sup>3</sup>*MSc*, Wei Zhi Leo <sup>4</sup>*BSc*, Beron Tan <sup>5</sup>*PhD*,  
Satyaki Sengupta <sup>6</sup>*DPT*, Jasper Tong <sup>6</sup>*PhD*,  
Mei Yoke Chan <sup>7</sup>*MMed*

<sup>1</sup>Physiotherapy Department, KK Women's and Children's Hospital, Singapore

<sup>2</sup>Child Life, Art and Music Therapy Programme, Rehabilitation Centre KK Women's and Children's Hospital, Singapore

<sup>3</sup>Occupational Therapy Services, Rehabilitation Centre, KK Women's and Children's Hospital, Singapore

<sup>4</sup>Speech Therapy Services, Rehabilitation Centre, KK Women's and Children's Hospital, Singapore

<sup>5</sup>Psychology Service, KK Women's and Children's Hospital, Singapore

<sup>6</sup>Allied Health Specialities, KK Women's and Children's Hospital, Singapore

<sup>7</sup>Paediatric Haematology/Oncology Services, KK Women's and Children's Hospital, Singapore

Correspondence: Ms Lindsey Weller, Physiotherapy Department, KK Women's and Children's Hospital, 100 Bukit Timah Road, Singapore 229899.

Email: lindsey.jean.rw@kkh.com.sg



## Implementation of an AI model to triage paediatric brain magnetic resonance imaging orders

### Dear Editor,

Artificial intelligence (AI) is viewed as the most important recent advancement in radiology with the potential to achieve Singapore's objective of delivering value-based patient-centric care.<sup>1</sup>

We have developed and implemented a deep-learning model using bidirectional long short-term memory (Bi-LSTM) neural network to enable automated triage of unstructured free-text paediatric magnetic resonance imaging (MRI) brain orders in conformance to the American College of Radiology (ACR) criteria<sup>2</sup> for appropriate utilisation of MRI. These ACR guidelines assist clinicians in the appropriate triaging of brain MRI orders for routine imaging, versus ultrafast MRI screening protocols for less appropriate orders.

After approval of waiver of consent from the Institution Review Board (CIRB reference number 2017/2078), data comprising 5,181 retrospective paediatric MRI brain orders (online Supplementary Table S1) extracted from 2006 to 2017 (excluding those with additional scans of other body parts and follow-up scans) were manually labelled for conformance to the ACR guidelines<sup>2</sup> under supervision of a senior paediatric radiologist. These were used as ground truth to develop a Bi-LSTM and other machine learning models to classify these free-text orders based on adherence to the ACR guidelines. Initially 2,470 orders from 2006 to 2013 were used for model training (80–20 training and validation split), and 2,711 orders from 2014 to 2017 for model testing, using receiver operating characteristics to measure model performance (online Supplementary Table S2). Another 50 orders from a 2020 audit were used for simulated implementation of the best performing model predicting MRI orders conforming to ACR guidelines,<sup>2</sup> comparing its performance against radiology staff with variable experience (including the aforesaid senior paediatric radiologist as gold standard), using Cohen's kappa statistics (online Supplementary Table S3). The model graphic user interface (Fig. 1) and details of its creation and testing are attached in the online Supplementary Materials.

The highest accuracy and area under the curve (AUC) were seen with the Bi-LSTM model (Supplementary Table S2). This model, utilised by a non-medical staff

such as a research assistant, has a kappa of 0.67, which shows evidence of a significant improvement compared to the kappa of 0.42 achieved by junior residents ( $P=0.01$ ). It is comparable to the kappa of 0.68 seen in residents with several years of neuroradiology experience although it remains less than the kappa of 0.72 attained by a junior paediatric radiologist and experienced MRI radiographers (Supplementary Table S3) ( $P<0.01$ ). An advantage of the Bi-LSTM model is its ability to map similar medical terms together while factoring sentence structure and context through a word vector matrix. In contrast, the bag-of-words traditional machine learning model requires more pre-processing steps and training time, results in a sparse dataset where each unique word represents a feature, and lacks the consideration of the contextual information derived from the sequence of words.

Model performance is likely dependent on both the model structure, and dataset size and complexity. Larger datasets with wide variability of data reflective of the real-life environment in which the model would be deployed are best for model creation. Machine learning is an evolving field and the numbers that constitute adequate sample sizes for developing prediction models are unclear, as evident from publications with sample sizes ranging from hundreds to millions.<sup>3-7</sup>

Incorporating a local interpretable model to explain each prediction outcome via a graphic user interface, builds confidence among non-medical or junior medical staff when protocoling MRI brain requests. In turn this will reduce the burden of MRI protocoling, increase productivity, and allow senior staff to focus on more pressing clinico-radiological issues. In addition, more objective criteria for MRI protocoling will reduce miscommunication and enhance radiology workflow efficiency.

Should busy physicians provide scanty information in their MRI orders, this may result in the model generating a low score for guideline adherence and the patient is triaged for an inappropriate ultrafast MRI brain protocol. Nevertheless, the radiology workflow provides an inherent additional safety net for patients with significant abnormalities, such as a mass. Radiographers, upon finding a mass on the initial MRI sequence, would



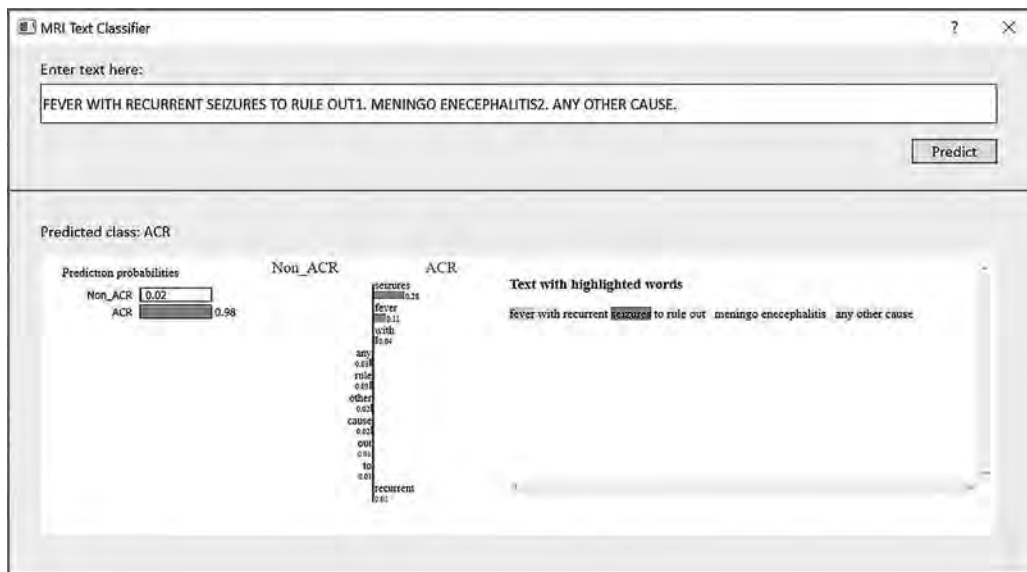

Fig. 1. User-friendly graphic user interface with case illustration of model explainer. Magnetic resonance imaging (MRI) indication on the electronic order form is copied and pasted into the textbox. Click of a button generates the percentage adherence to guidelines, with clear display of words that support the adherence to guidelines. An order with a generated percentage of less than 50% is deemed suitable for a screening ultrafast MRI brain protocol.

obtain radiologist clearance to convert the ultrafast protocol into a comprehensive MRI brain scan, including the addition of contrast-enhanced sequences.

Adherence to guidelines decreased across the years, with 76% adherence on the initial training dataset (2006–2013) dropping to 61% on the test dataset (2014–2017) and 40% adherence on the 2020 dataset. Paediatric MRI brain orders may deviate from evidence-based guidelines for a variety of reasons, such as uncertainties in the clinical assessment of an uncooperative child, pressure from anxious caregivers, and the potential for malpractice suits due to missed pathology. In practice, even though an MRI order may not comply with the radiological guidelines, a negative MRI scan does allay anxiety and promptly narrows management options for the patient.

Ultrafast or abbreviated protocols are increasingly proposed for suitable patients as an alternative to the full MRI protocol due to shorter acquisition time while maintaining diagnostic accuracy,<sup>8</sup> ensuring effective utilisation of expensive MRI equipment. Screening protocols can be both clinically efficient and cost-effective when used for MRI brain requests with a low probability of having brain abnormalities in both children<sup>9</sup> and adults.<sup>10</sup>

The primary limitation of our study is that the models were trained on labelled paediatric datasets from a single hospital and implemented within the same hospital.

External validity would be required to deploy the model beyond the confines of our hospital. Our model could also be further trained on an adult population, incorporating radiological terms from a different case mix, which would increase model robustness and generalisability. Future work could incorporate cross-institutional data and the cost-effectiveness analysis to better evaluate the efficacy of the model in improving radiology practices, and the correlation of outcomes of automated triaging of free-text MRI orders with actionable abnormality in the final MRI report.

In conclusion, radiology departments can consider leveraging on artificial intelligence to create user-friendly and explainable triage models. These can help the non-medical or junior staff determine if MRI orders are appropriate and facilitate workflow to help cope with an overwhelming demand for this expensive and limited imaging resource.

#### Funding

This study was funded by Health Services Research and Analytics Technologies for SingHealth grant (HEARTS 2017/024) and KKH NMRC Centre Grant Programme (NMRC/CG/M002/2017\_KKH).

#### Acknowledgements

The authors would like to acknowledge the contributions and support of the initial members of the study team, especially Khine Nwe Win, Kathy Low, Edna Aw, Emily Chai, Tsang Wing Sze, Audrey Ling, Conceicao Edwin Philip and Amanda Choo for their help towards the curation of the datasets and the initial preliminary analysis of the study.

## REFERENCES

1. Liew CJ, Krishnaswamy P, Cheng LT, et al. Artificial Intelligence and Radiology in Singapore: Championing a New Age of Augmented Imaging for Unsurpassed Patient Care. *Ann Acad Med Singap* 2019;48:16-24.
2. American College of Radiology. ACR–ASNR–SPR practice parameter for the performance and interpretation of magnetic resonance imaging (MRI) of the brain, 2013. <https://www.asnr.org/wp-content/uploads/2019/06/MR-Brain.pdf>. Accessed 14 April 2017.
3. Chen MC, Ball RL, Yang L, et al. Deep learning to classify radiology free-text reports. *Radiology* 2018;286:845-52.
4. Hassanpour S, Langlotz CP, Amrhein TJ, et al. Performance of a Machine Learning Classifier of Knee MRI Reports in Two Large Academic Radiology Practices: A Tool to Estimate Diagnostic Yield. *AJR Am J Roentgenol* 2017;208:750-3.
5. Huhdanpaa HT, Tan WK, Rundell SD, et al. Using Natural Language Processing of Free-Text Radiology Reports to Identify Type 1 Modic Endplate Changes. *J Digit Imaging* 2018;31:84-90.
6. Cheng LT, Zheng J, Savova GK, et al. Discerning tumor status from unstructured MRI reports--completeness of information in existing reports and utility of automated natural language processing. *J Digit Imaging* 2010;23:119-32.
7. Lakhani P, Kim W, Langlotz CP. Automated detection of critical results in radiology reports. *J Digit Imaging* 2012;25:30-6.
8. Ahamed SH, Lee KJ, Tang PH. Role of a modified ultrafast MRI brain protocol in clinical paediatric neuroimaging. *Clin Radiol* 2020;75:914-20.
9. Expert Panel on Pediatric Imaging: Hayes LL, Palasis S, et al. ACR Appropriateness Criteria® Headache-Child. *J Am Coll Radiol* 2018;15:S78-90.
10. Lim JLL, McAdory LE, Tang PH, et al. Appropriateness of MRI brain orders: Application of American and British guidelines. *J Neurol Sci* 2020;414:116874.

Phua Hwee Tang <sup>1</sup>*FRCR*, Alwin Yaoxian Zhang <sup>2</sup>*MSc*,  
Sean Shao Wei Lam <sup>2</sup>*PhD*, Marcus Eng Hock Ong <sup>3</sup>*FRCGS*,  
Ling Ling Chan <sup>4</sup>*FRCGS*

<sup>1</sup>Department of Diagnostic and Interventional Imaging, KK Women's and Children's Hospital, Singapore

<sup>2</sup>Health Service Research Centre, SingHealth, Singapore

<sup>3</sup>Emergency Medicine, Singapore General Hospital, Singapore

<sup>4</sup>Department of Diagnostic Imaging, Singapore General Hospital, Singapore

Correspondence: Dr Phua Hwee Tang, Department of Diagnostic and Interventional Imaging, KK Women's and Children's Hospital, 100 Bukit Timah Road, Singapore 229899.  
Email: tang.phua.hwee@singhealth.com.sg

## Erdheim-Chester disease: Imaging spectrum of multisystemic manifestations

### Dear Editor,

Erdheim-Chester disease (ECD) is a rare non-Langerhans histiocytosis, usually affecting middle-aged to older adults. It is a multisystemic disease with protean clinical manifestations. It can involve single or multiple organs, and presentations range from asymptomatic lesions detected incidentally on imaging to severe organ dysfunction. Hence, accurate and timely diagnosis is a challenge. The diagnosis of ECD is a multidisciplinary effort where imaging plays a central role in diagnosis to assess disease burden, and direct lesional biopsy and follow-up. While the final diagnosis is established by histopathology, the initial diagnosis is often suggested on imaging.

**Pathogenesis.** ECD is a malignancy of myeloid progenitor cells. Acquired somatic mutation of *BRAF* or other components of the MAPK signalling pathway are present in most patients with ECD. Mutant *BRAF* activating the RAS/RAF/MEK/MAPK signalling pathway is the most common mutation.<sup>1</sup> Mutant *BRAF* increases cell proliferation and drives the malignant process in ECD. Detection of the characteristic *BRAF* mutation in subsets of dendritic cells, mature monocytes, committed myeloid progenitors, and CD34+ cells is helpful for the diagnosis. For symptomatic patients with the *BRAF* mutation, a *BRAF* inhibitor like vemurafenib is available as targeted therapy. Mutations affecting other signalling molecules (e.g. NRAS, KRAS and ALK) may also be found. These may be treated with MEK inhibitors.<sup>2,4</sup>

**Bones.** There is an almost universal involvement of the skeletal system in ECD.<sup>3</sup> Patients may present with non-specific mild bone pain. The radiographic features are pathognomonic with bilateral symmetrical osteosclerosis of the metadiaphysis of long tubular bones of the appendicular skeleton with relative sparing of epiphyses.<sup>3,4</sup> Cortical thickening and trabecular coarsening may be seen. Lytic lesions are uncommon.

On bone scintigraphy, ECD shows intense symmetrical tracer uptake in the appendicular skeleton, with sparing of the epiphyses. Fluorodeoxyglucose (FDG) positron emission tomography-computed tomography (PET-CT) scan shows a similar pattern of tracer uptake.<sup>3,4</sup>

**Central nervous system (CNS) and orbits.** Neurological involvement is seen in about 40% of

ECD cases with diverse clinical manifestations including cognitive impairment, cerebellar and pyramidal syndromes, diabetes insipidus, neuropathies, seizures and headaches.<sup>4-6</sup> Screening for CNS lesions is recommended for all patients with ECD as neurological involvement often results in severe handicap and mortality.<sup>6</sup>

The most common site of CNS involvement is the hypothalamic-pituitary axis. Findings include loss of normal T1-weighted (T1W) bright signal of the posterior pituitary, thickening and enhancing nodular mass(es) involving the pituitary stalk, and empty sella.<sup>4,7</sup>

Other CNS lesions in ECD include meningeal, intra-axial and perivascular lesions.<sup>8</sup> Meningeal lesions may manifest as focal single or multiple meningioma-like masses, diffuse pachymeningeal thickening, or a combination of both. Intra-axial lesions are widely distributed, and are more common in the periventricular region, pons, midbrain and cerebellum. These include multiple focal masses and non-enhancing bilateral symmetric low T1W and high T2-weighted (T2W) signal lesions. Perivascular involvement is seen as periarterial enhancing infiltration or venous sinus lesions. CNS lesions are rarely associated with perilesional oedema or mass effect.<sup>4-8</sup>

Orbital involvement is seen in approximately 30–40% of cases, presenting as bilateral exophthalmos.<sup>8</sup> On imaging, these manifest as unilateral or bilateral masses in the intraconal or less commonly, extraconal compartment.

The combination of diabetes insipidus, bone pain and exophthalmos should raise suspicion of ECD. While the individual CNS findings are non-specific, presence of multiple anatomical sites of CNS involvement (seen in 50% of patients) is a useful clue for ECD.

**Lungs and pleura.** Lung disease in ECD results from peribronchovascular, interlobular septal and fissural histiocytic infiltration.

Patients are often asymptomatic or may have dry cough and dyspnoea. Up to 50% of patients show involvement of the lungs and pleura on the CT scan. Lung findings include reticular interstitial opacities, focal or diffuse smooth interlobular septal and fissural thickening, multifocal ground-glass attenuation, and centrilobular nodules.<sup>9</sup> Honeycombing is rare. Pleural

ECD lesions result in focal or diffuse pleural thickening with unilateral or bilateral pleural effusions.<sup>10</sup> While the interstitial lung disease in ECD has no specific pattern or site predilection, the presence of lung and pleural lesions in combination with typical skeletal findings suggests the diagnosis.

**Cardiac and mediastinum.** Cardiac ECD lesions are seen in up to 40–70% of cases and may involve the pericardium, myocardium and coronary arteries.<sup>10</sup> Clinical presentations include arrhythmias, myocardial ischaemia, valvular dysfunction and heart failure. These are more common in older patients and constitute

significant mortality. The pericardium may be thickened with effusion that can cause cardiac tamponade. Myocardial infiltration usually involves the right atrium and right atrioventricular groove. Myocardial involvement is best seen on magnetic resonance imaging (MRI) as T1W hypointense focal lesions with post-contrast enhancement.<sup>10</sup> Coronary artery involvement affects up to 30% of patients, most commonly the right coronary artery with stenosis and territorial ischaemia. Published consensus guidelines recommend cardiac MRI in all patients at baseline to identify involvement and evaluate the extent of ECD.<sup>11</sup>

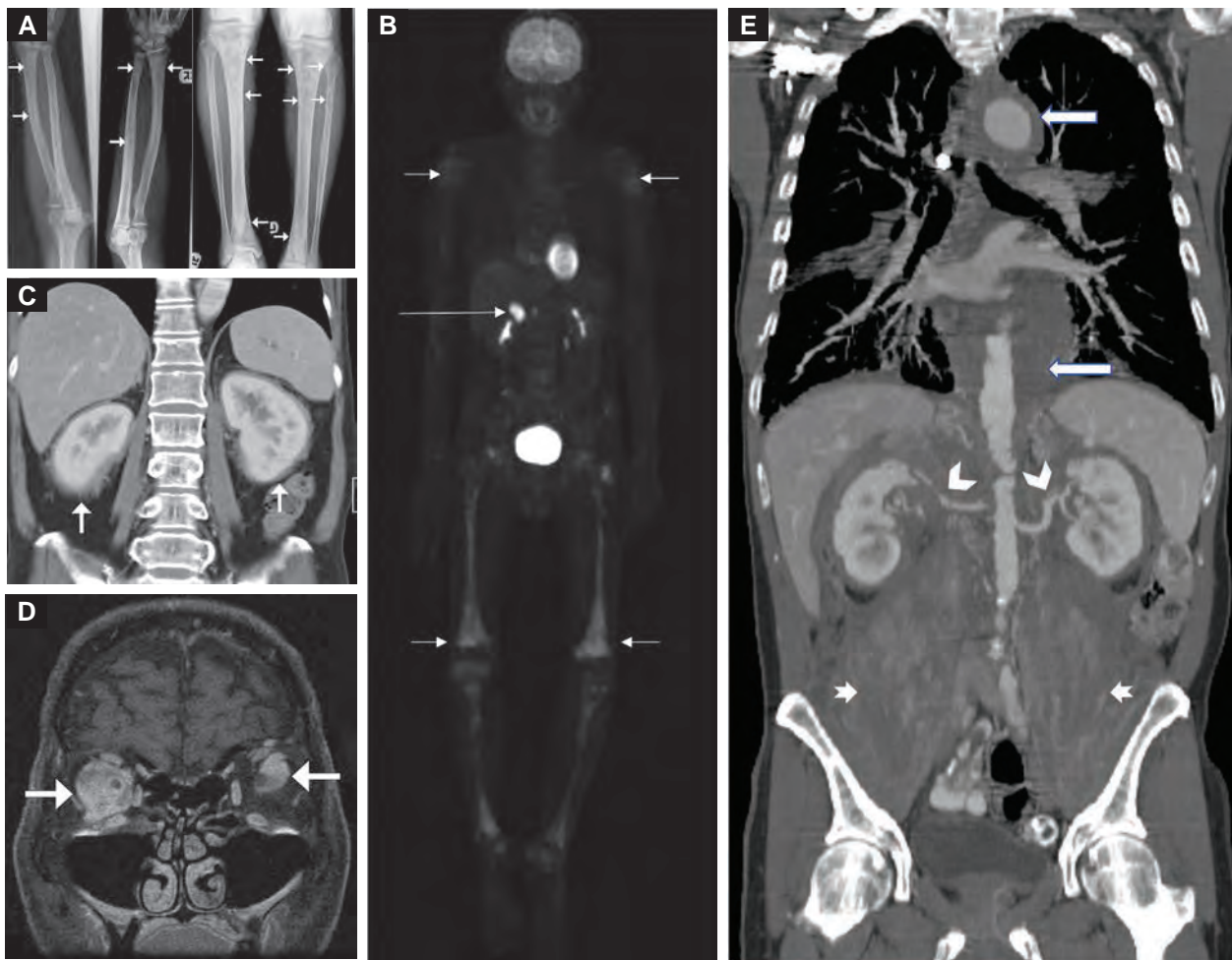

Fig. 1. Imaging findings for Erdheim-Chester disease (ECD). (A) Radiographs of the upper and lower limbs show characteristic bilateral symmetrical involvement of the long bones, with heterogenous sclerosis of the diaphyses and metaphyses (arrows). (B) Whole-body fluorodeoxyglucose (FDG) positron emission tomography (PET) scan shows bilateral and symmetrical raised metabolic activity in the long bones of the upper and lower limbs (short arrows). An extraskeletal site of ECD is in the enlarged, FDG-avid right adrenal gland (long arrow). (C) The “hairy kidney” sign. Contrast-enhanced axial computed tomography (CT) scan shows bilateral and symmetrical irregular soft-tissue infiltration (arrows) in the perirenal spaces. (D) Magnetic resonance imaging (MRI) scan showing orbital ECD lesions. Coronal gadolinium-enhanced fat-suppressed T1-weighted MRI scan shows avid homogeneous enhancement of the intraconal lesions. (E) Retroperitoneal, vascular and muscular involvement in ECD. Coronal enhanced CT scan shows periaortic infiltration along the entire length of the aorta (long arrows) creating a “coated aorta” appearance. The abnormal soft tissue is encasing bilateral renal arteries causing irregular luminal narrowing (arrowheads). There is also diffuse infiltration of bilateral psoas muscles (short arrows).



Mediastinal involvement manifests as soft tissue infiltration, which shows moderate FDG uptake on PET-CT scan. These may encase and narrow the pulmonary arteries and superior vena cava.

**Vascular.** Vascular involvement results from histiocytic infiltration of the adventitia with periarterial fibrosis, causing arterial stenosis/occlusion and end-organ ischaemia. The aorta is most commonly affected with involvement in 56–85% of patients,<sup>4</sup> seen as circumferential hypodense and mildly enhancing infiltration on CT scan. Diffuse and circumferential involvement of thoracic and abdominal aorta gives the characteristic “coated aorta” appearance—a key diagnostic sign of ECD seen in 23–30% of patients (Fig. 1).<sup>3,4</sup> On MRI scan, vascular infiltration is isointense to muscle on T1W and T2W sequences, and shows post-gadolinium enhancement. Increased uptake is seen on FDG PET-CT.

**Renal and retroperitoneum.** Approximately 70% of ECD patients have urologic or retroperitoneal involvement. Urological symptoms include abdominal pain, lower urinary tract symptoms, chronic renal insufficiency and renovascular hypertension, but these are uncommon at initial presentation.<sup>3,4,12</sup>

Histiocytic infiltration of bilateral perirenal spaces manifests on CT scan as low-density soft-tissue infiltrates, giving the “hairy kidney” sign (Fig. 1)—a key imaging feature seen in up to 68% of patients. On MRI scan, the infiltrates are isointense to muscle on T1W and T2W sequences and show mild homogenous enhancement.<sup>1,5</sup> Extension to the renal sinus and ureters may result in hydronephrosis. Other complications include renal artery stenosis and chronic kidney disease.<sup>12</sup>

Adrenal involvement is seen in up to 32% of patients. Imaging findings include diffuse symmetrical bilateral thickening and bulky masses.<sup>1,5</sup>

**Imaging guidelines.** Given the multisystemic involvement, a wide array of radiological modalities is needed. Baseline imaging work-up consisting of whole-body FDG PET-CT; contrast-enhanced MRI of the brain; cardiac MRI; and CT of the chest, abdomen and pelvis should be done in all patients to identify disease burden including clinically occult lesions. Imaging follow-up with FDG PET-CT once every 3–6 months is recommended after initiation of treatment. Additionally, organ-specific imaging is recommended every 3 months following treatment initiation, followed by imaging once every 6 months once disease stabilises.<sup>1,11</sup>

## REFERENCES

1. Haroche J, Charlotte F, Arnaud L, et al. High prevalence of *BRAF V600E* mutations in Erdheim-Chester disease but not in other non-Langerhans cell histiocytoses. *Blood* 2012;120:2700-3.
2. Diamond EL, Durham BH, Haroche J, et al. Diverse and Targetable Kinase Alterations Drive Histiocytic Neoplasms. *Cancer Discov* 2016;6:154-65.
3. Antunes C, Graça B, Donato P. Thoracic, abdominal and musculoskeletal involvement in Erdheim-Chester disease: CT, MR and PET imaging findings. *Insights Imaging* 2014;5:473-82.
4. Goyal G, Heaney ML, Collin M, et al. Erdheim-Chester disease: consensus recommendations for evaluation, diagnosis, and treatment in the molecular era. *Blood* 2020;135:1929-45.
5. Boyd LC, O'Brien KJ, Ozkaya N, et al. Neurological manifestations of Erdheim-Chester Disease. *Ann Clin Transl Neurol* 2020;7:497-506.
6. Lachenal F, Cotton F, Desmurs-Clavel H, et al. Neurological manifestations and neuroradiological presentation of Erdheim-Chester disease: report of 6 cases and systematic review of the literature. *J Neurol* 2006;253:1267-77.
7. Wang F, Cao X, Niu N, et al. Multisystemic Imaging Findings in Chinese Patients With Erdheim-Chester Disease. *AJR Am J Roentgenol* 2019;213:1179-86.
8. Drier A, Haroche J, Savatovsky J, et al. Cerebral, facial, and orbital involvement in Erdheim-Chester disease: CT and MR imaging findings. *Radiology* 2010;255:586-94.
9. Wittenberg KH, Swensen SJ, Myers JL. Pulmonary involvement with Erdheim-Chester disease: radiographic and CT findings. *AJR Am J Roentgenol* 2000;174:1327-31.
10. Das JP, Xie L, Riedl CC, et al. Cardiothoracic manifestations of Erdheim-Chester disease. *Br J Radiol* 2019;92:20190473.
11. Diamond EL, Dagna L, Hyman DM, et al. Consensus guidelines for the diagnosis and clinical management of Erdheim-Chester disease. *Blood* 2014;124:483-92.
12. Yelfimov DA, Lightner DJ, Tollefson MK. Urologic manifestations of Erdheim-Chester disease. *Urology* 2014;84:218-21.

Amos Hui Sheng Tan<sup>1</sup>*MMed (Diag Radiol)*,  
 Sunita Dhandu<sup>2</sup>*FRCR*, Pooja Jagmohan<sup>1,3</sup>*FRCR*,  
 Pavel Singh<sup>1,3</sup>*FRCR*,  
 James Thomas Patrick Decourcy Hallinan<sup>1,3</sup>*FRCR*,  
 Swee Tian Quek<sup>1</sup>*FRCR*

<sup>1</sup> Department of Diagnostic Imaging, National University Hospital, Singapore

<sup>2</sup> Global Diagnostics, Mandurah, Western Australia, Australia

<sup>3</sup> Department of Diagnostic Radiology, Yong Loo Lin School of Medicine, National University of Singapore, Singapore

Correspondence: Dr Amos Hui Sheng Tan, Department of Diagnostic Imaging, National University Hospital, Level 2 Main Building, 5 Lower Kent Ridge Road, Singapore 119074.

Email: amos\_hs\_tan@nuhs.edu.sg



## A strategy to make COVID-19 vaccination more accessible to the elderly

### Dear Editor,

Singapore embarked on the COVID-19 National Vaccination Programme in early 2021. The main modality employed to achieve the mass vaccinations has been the Vaccination Centres (VCs). These are dedicated facilities created with the sole purpose of providing the public with safe and convenient access to vaccination services.

While the VCs served their function well for most of the resident population, there is a small proportion of individuals who face challenges in going to the VCs for their vaccinations. These individuals are often part of a vulnerable section of society, and hence, there is an even greater impetus to ensure that vaccination services are readily available to them. To address this need, mobile teams were established to bring vaccination services to the doorstep. The concept of mobile teams providing vaccinations is not new, and has been shown to be effective in improving vaccination rates within the community at large, as well as in specific groups such as healthcare workers.<sup>1,2</sup>

The first Mobile Vaccination Team (MVT) was formed in December 2020 under the purview of the Ministry of Health (MOH), Singapore. While the concept of MVTs has been developed by MOH and their deployment remains centrally managed, these teams are set up and run by private medical service providers. An MVT is led by a registered medical practitioner, and can be deployed in 2 configurations (determined by the projected demand for vaccination services at the chosen site). A full team comprises 4 registered nurses and 3 support staff, while a subteam comprises 1 registered nurse and 1 support staff. A fully configured MVT can vaccinate up to 150 individuals per day.

The Home Vaccination Team (HVT) is a small vaccination team that can be deployed directly to individual residences. This allows the provision of vaccination services to even the most vulnerable persons. A HVT comprises only 2 team members: a registered medical practitioner and a registered nurse. The vaccination capacity of a HVT is extremely limited, and is usually reserved for individuals who are homebound or have significant mobility issues. A HVT can be deployed to up to 12 different residences per day, and the number of persons vaccinated will depend on the number of eligible persons per household visited.

In the initial period, the first MVT deployment was to a nursing home in Buangkok Green Medical Park on 12 January 2021, while the first HVT deployment was to a personal residence on 10 May 2021. Following this, the MVTs were deployed to other nursing homes to assist with on-site vaccination of the residents. This was then expanded to provide on-site vaccinations for major government agencies, statutory boards and other institutions such as the Health Sciences Authority, Ministry of Communications and Information, Singapore Prisons Service, etc. There was also limited deployment to shopping malls prior to the introduction of Vaccination-differentiated safe management measures (VDS). VDS is a set of guidelines that define the safe management measures that can be accorded to individuals who are fully vaccinated. It was first implemented on 10 August 2021.<sup>3</sup> Such deployments were planned as a result of a direct request to MOH for vaccination services on-site.

Eventually, the MVTs were deployed to the heartlands to help to encourage vaccinations in specific townships, which were lagging behind in terms of overall vaccination rate. These townships were identified through a combination of data obtained from national databases, as well as feedback from grassroots organisations and local community leaders. For on-site vaccinations, the requesting organisation would provide a suitable space for the deployment, such as a multipurpose hall or function room. Deployments to the heartlands are typically to community spaces such as Community Clubs, Residents' Committees, and even void decks or neighbourhood pavilions within blocks of Housing and Development Board (HDB) flats where the majority of the Singapore population reside.

During each deployment, the COVID-19 vaccines are kept in a high-quality cooler box, thus allowing the vaccines to be maintained at the required temperature of 2–8°C for about 9 hours. A temperature logging device placed within the cooler box provides real-time temperature monitoring and also serves as an alert to any temperature excursions. The main challenge faced by the mobile vaccination teams was optimising supply-and-demand matching. This was largely overcome by keeping accurate and up-to-date nominal rolls of the intended vaccinees (for on-site vaccinations), and ensuring good ground engagement and publicity to the residents at the planned sites of deployments (for MVTs deployed to HDB heartlands).

Table 1. Percentage of COVID-19 vaccine doses administered by Home Vaccination Teams (HVTs) and Mobile Vaccination Teams (MVTs) from 30 December 2020 to 30 March 2022

Age, years	Dose of vaccine administered	HVTs, %	MVTs, %	Combined total, %	Overall national vaccination rate, %
≥80	First	3.2	5.9	9.1	94.6
	Completed primary series	3.3	5.6	9.0	93.9
	Booster 1	3.0	4.1	7.2	78.1
70–79	First	0.6	2.0	2.5	96.5
	Completed primary series	0.6	1.9	2.5	96.2
	Booster 1	0.6	1.7	2.3	85.7
60–69	First	0.2	1.1	1.3	96.9
	Completed primary series	0.2	1.0	1.2	96.7
	Booster 1	0.2	0.9	1.1	87.3

Values for “completed primary series” comprise individuals who had completed vaccine combinations requiring  $\geq 2$  doses (e.g. Sinovac-CoronaVac 3-dose primary series).

Our records show that the elderly primarily benefited from the mobile team deployments (in particular, persons aged  $\geq 80$  years). For the period 30 December 2020 to 30 March 2022 and for all persons aged  $\geq 60$  years, the HVTs and MVTs contributed to 1.1–9.1% of all doses administered, inclusive of primary series and first booster doses (Table 1).

The percentage of individuals vaccinated by the HVTs and MVTs largely corresponds with the national vaccination rate. A possible reason for the decline after the first dose may be that some individuals opted to receive subsequent doses at the VCs, instead of waiting for the opportunistic deployments of the MVTs. Furthermore, as the number of VCs increased over time, visiting a VC gradually became more convenient. The likelihood of this reason may be further supported by the percentages of vaccines delivered by the HVTs that remained largely unchanged for the respective age bands, as we do not expect the mobility status of this group of residents to change significantly over time.

While the overall fraction of the elderly vaccinated by the mobile HVTs and MVTs is not very large, these individuals are at the highest risk of complications from COVID-19 infection. Each elderly person vaccinated contributes to the protection of one at-risk person from hospitalisation and severe disease.<sup>4,5</sup> The HVTs and MVTs have brought vaccinations closer to the elderly and will continue to play an integral role in our vaccination capabilities going forward.

#### Acknowledgements

We would like to thank Mr Kuppusamy Ramanujam Vignesh, Deputy Director (Data Fusion) and the rest of the Data Fusion team, Operations

Systems Development and Data Division, Crisis Strategy and Operations Group, MOH for providing the anonymised data used in this paper. We also thank Mr James KB Lim, Deputy Director (MVT & HVT), and the rest of the team from the Vaccination Operations Task Group, Crisis Strategy and Operations Group, MOH for providing the details pertaining to the Mobile and Home Vaccination Teams.

#### REFERENCES

1. Semá Baltazar C, Rafael F, Langa JPM, et al. Oral cholera vaccine coverage during a preventive door-to-door mass vaccination campaign in Nampula, Mozambique. *PLoS One* 2018;13:e0198592.
2. Navalón Ramon E, Martínez Pardo I, Sendra Barbosa T, et al. Uso de equipos móviles para aumentar la cobertura vacunal antigripal entre el personal sanitario. Ensayo comunitario de intervención [Use of mobile immunization teams to increase influenza vaccination coverage among healthcare workers. A community intervention trial]. *Rev Esp Salud Publica* 2019;93:e201904017.
3. Ministry of Health, Singapore. Information on vaccination-differentiated safe management measures (SMMS), 27 January 2022. [https://www.moh.gov.sg/docs/librariesprovider5/2019-ncov/220127-vds-info-sheet\\_booster\\_for-uploading-v2.pdf](https://www.moh.gov.sg/docs/librariesprovider5/2019-ncov/220127-vds-info-sheet_booster_for-uploading-v2.pdf). Accessed 18 September 2022.
4. Chen Y, Klein SL, Garibaldi BT, et al. Aging in COVID-19: Vulnerability, immunity and intervention. *Ageing Res Rev* 2021;65:101205.
5. Tenforde MW, Self WH, Adams K, et al. Association Between mRNA Vaccination and COVID-19 Hospitalization and Disease Severity. *JAMA* 2021;326:2043-54.

Soon Hoong Daniel Chow <sup>1</sup>*MBBS*, Si Jack Chong <sup>2</sup>*FAMS*

<sup>1</sup> Healthier SG Task Group, Crisis Strategy and Operations Group, Ministry of Health, Singapore

<sup>2</sup> Medical Operations and Policy Centre, Crisis Strategy and Operations Group, Ministry of Health, Singapore

Correspondence: Dr Soon Hoong Daniel Chow, Healthier SG Task Group, Crisis Strategy and Operations Group, Ministry of Health, Singapore, 238B Thompson Road, #13-00 Novena Square Office Tower B, Singapore 307684.

Email: Daniel\_sh\_chow\_from.CSOG@moh.gov.sg

## A recurring nasal mass

A 56-year-old Chinese man presented to the Ear, Nose and Throat clinic with months of unilateral right-sided nasal obstruction. He reported occasional mucopurulent discharge and denied any hyposmia, episodes of epistaxis, or loss of weight and appetite. Nasoendoscopy revealed a right-sided nasal mass between the septum and middle turbinate. Magnetic resonance imaging (MRI) showed a 6.9cm right nasal cavity mass extending from the cribriform plate to the hard palate inferiorly, laterally abutting the ostiomeatal unit and medially abutting the nasal septum. No intracranial or orbital wall extension was seen (Fig. 1).

The patient underwent an open craniofacial resection with clear margins on the intra-operative frozen section, as well as a staged bilateral modified radical neck dissection that yielded no nodal metastases. This was followed by adjuvant radiotherapy. Unfortunately, the patient developed a local recurrence in the left nasopharynx 6 months post-radiotherapy for which he underwent a salvage endoscopic nasopharyngectomy.

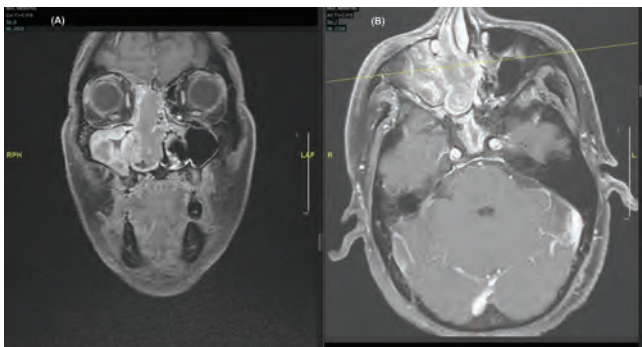

Fig. 1. Coronal (A) and axial (B) views of T1-weighted magnetic resonance imaging with contrast.

A second local recurrence occurred one year post-nasopharyngectomy in the right nasopharynx for which he declined further surgery. Since then, regular office debridement and topical 5-fluorouracil (5-FU) have become the mainstay of treatment for this patient (Fig. 2), which has achieved good control with varying frequencies of application over the last 8 years (Fig. 3).

On surveillance MRI (after 8 years of topical 5-FU application), a persistent but stable right fossa of Rosenmüller mass was noted.

Which sinonasal tumour is known to be locally controlled by the topical application of 5-FU?

- A. Esthesioneuroblastoma
- B. Mucoepidermoid carcinoma
- C. Sinonasal adenocarcinoma
- D. Sinonasal squamous cell carcinoma
- E. Adenoid cystic carcinoma

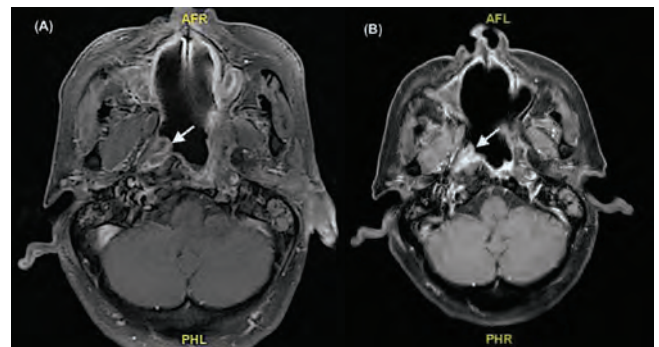

Fig. 3. Axial views of T1-weighted magnetic resonance imaging with contrast taken in 2012 after left nasopharyngectomy (A) and after 8 years of topical 5-FU application (B). White arrow marks the tumour, which has not changed in size due to the topical regime.

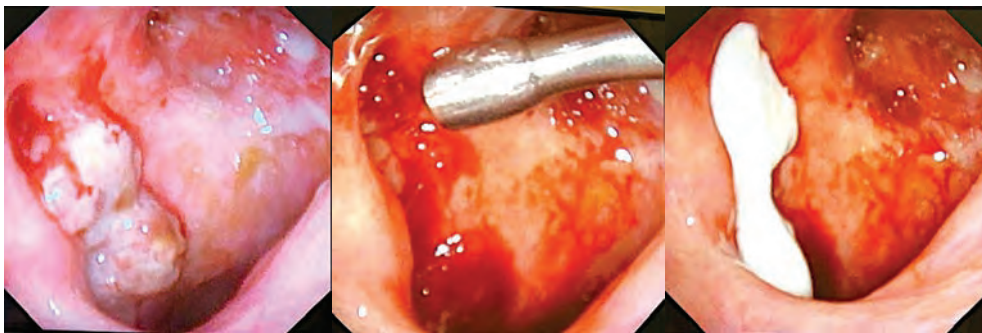

Fig. 2. Nasoendoscopic images of nasal tumour at right fossa of Rosenmüller before and after debridement, and subsequent 5-fluorouracil application.

Answer: C



Sinonasal adenocarcinoma (SNAC) is an uncommon malignant tumour, making up only around 10–20% of malignant tumours originating from the sinonasal space, coming second only to sinonasal squamous cell carcinoma (SCC) in incidence across the world. Cancers of the paranasal sinuses are extremely uncommon, making up only 3% of total head and neck malignancies. While the incidence of SNAC has always been reported to be more common in men, presumably supported by the higher likelihood of men being involved in work environments with known risk factors, recent studies<sup>1</sup> report that the incidence is similar in both men and women.

SNAC can arise from seromucinous glands and the surface epithelium of the sinonasal tract. According to the World Health Organization, classifications of adenocarcinomas can be split into salivary-type and non-salivary-type carcinomas, of which the latter involves either intestinal or non-intestinal subtypes. Intestinal-type adenocarcinoma, which the patient had, bears histological and immunohistochemical resemblance to the mucosa of small and large intestines. The association of long-term occupational hardwood-dust exposure with the development of SNAC,<sup>2</sup> in particular the intestinal type, has been widely established in the literature.

In general, SNAC commonly arises from ethmoid sinus<sup>3</sup> and tends to present late though tumours in other sinuses can also have a late presentation unless picked up incidentally. Common manifestations include nasal obstruction, bloody discharge, anosmia, and extension into adjacent tissue can cause vision loss and exophthalmos. Identifying<sup>4</sup> the tumour is more challenging because of its location and the non-specific nature of symptoms. Computed tomography (CT) and MRI are complementary tests for localising and determining the size and extension of the tumour, especially in key structures<sup>5</sup> such as orbital apex, dura mater and beyond. The risk of regional and distant metastases of the tumour has been described to be low, which according to current literature<sup>3,6</sup> ranges from 2–10%. Positron emission tomography/CT was previously done to assess for distal metastasis, but the focus was more on MRI for this patient to determine the local control achieved by topical 5-FU application.

The imaging features<sup>7</sup> of adenocarcinomas are often indistinguishable from those of other sinonasal cancers. Both SCC and SNAC can commonly appear as solid, heterogeneous masses with areas of necrosis and irregular margins with osseous destruction.

Sinonasal tumours can be managed in various manners. Surgical removal usually entails a craniofacial resection (CFR), especially for tumours extending into the anterior skull base. Approaches include open, endoscopic and combined. The open approach is more likely to be employed with increasing brain involvement by the tumour. However, an endoscopic approach has been reported to allow clearer visualisation of limits<sup>8</sup> and attachment sites of the mass, hence a more precise resection and a hybrid approach may therefore be appropriate in some cases.

For SNAC,<sup>9</sup> the utility of repeated application of 5-FU as a chemotherapy agent has been reported to be a good alternative to surgery and offers excellent results with a 5-year disease-free survival rate of up to 87%. The general principles include regular necrotomy (which can be done in the clinic) and the application of 5-FU over areas of possible tumour involvement.

Based on current literature,<sup>9,10</sup> the frequency of initial topical 5-FU application was not well defined, but varied from a regimen of once weekly for 6 weeks before monthly follow-up and regular tissue biopsies, to a regimen of twice-weekly for a total of 4 weeks (accounting for 8 sessions in total) followed by a 2-month break before the endoscopic inspection. Here, a weekly therapy was initiated for a total of 6 sessions before a rest of 3 months. Subsequently on follow-up, the treatment intervals were lengthened to a monthly regime. Due to a high risk of local recurrence, treatment duration is anticipated to be lifelong for this patient.

In summary, SNAC can be well controlled with regular debridement and topical application of 5-FU. Such a treatment regime may allow the avoidance of major surgery in a poor surgical candidate, as well as provide long-term control of recurrences post-surgery. In general, resection of the tumour would be preferred whenever ideal. Topical 5-FU application would be best employed in smaller areas that are unresectable, or in this case where the patient refused surgery.

#### REFERENCES

1. D'Aguillo CM, Kanumuri VV, Khan MN, et al. Demographics and survival trends of Sinonasal adenocarcinoma from 1973 to 2009. *Int Forum Allergy Rhinol* 2014;4:771-6.
2. Leivo I. Sinonasal adenocarcinoma: Update on classification, Immunophenotype and molecular features. *Head Neck Pathol* 2016;10:68-74.
3. Llorente JL, Pérez-Escuredo J, Alvarez-Marcos C, et al. Genetic and clinical aspects of wood dust related intestinal-type sinonasal adenocarcinoma: A Review. *Eur Arch Otorhinolaryngol* 2009;266:1-7.

4. Orvidas LJ, Lewis JE, Weaver AL, et al. Adenocarcinoma of the nose and paranasal sinuses: A retrospective study of diagnosis, histologic characteristics, and outcomes in 24 patients. *Head Neck* 2005;27:370-5.
5. Michel J, Radulesco T, Penicaud M, et al. Sinonasal adenocarcinoma: Clinical outcomes and predictive factors. *Int J Oral Maxillofac Surg* 2017;46:422-7.
6. Caselhos S, Ferreira C, Jácome M, et al. Liver metastasis of ethmoid sinus adenocarcinoma. *Eur Ann Otorhinolaryngol Head Neck Dis* 2015;132:157-9.
7. Rodrigo JP, García-Pedrero JM, Llorente JL, et al. Down-regulation of annexin A1 and A2 protein expression in intestinal-type sinonasal adenocarcinomas. *Hum Pathol* 2011;42:88-94.
8. Chatelet F, Simon F, Bedarida V, et al. Surgical management of sinonasal cancers: A comprehensive review. *Cancers* 2021;13:3995.
9. Knegt PP, Ah-See KW, vd Velden LA, et al. Adenocarcinoma of the ethmoidal sinus complex: surgical debulking and topical fluorouracil may be the optimal treatment. *Arch Otolaryngol Head Neck Surg* 2001;127:141-6.
10. Almeyda R, Capper J. Is surgical debridement and topical 5 fluorouracil the optimum treatment for woodworkers' adenocarcinoma of the ethmoid sinuses? A case-controlled study of a 20-Year experience. *Clin Otolaryngol* 2008;33:435-41.

Javier Lek Wei Loo<sup>1</sup>, Caroline Chun Yun Lee<sup>2</sup>*MMED ORL*,  
 Jeevendra Kanagalingam<sup>1,3,4</sup>*FRCs (ORL-HNS)*,  
 Christopher GL Hobbs<sup>3,4</sup>*FRCs (ORL-HNS)*,  
 Ming Yann Lim<sup>2</sup>*FAMS ORL*

<sup>1</sup> Lee Kong Chian School of Medicine, Nanyang Technological University, Singapore

<sup>2</sup> Department of Otorhinolaryngology, Tan Tock Seng Hospital, Singapore

<sup>3</sup> Mount Elizabeth Novena Hospital, Singapore

<sup>4</sup> Gleneagles Hospital, Singapore

Correspondence: Dr Ming Yann Lim, Department of Otorhinolaryngology, Tan Tock Seng Hospital, 11 Jln Tan Tock Seng, Singapore 308433.  
 Email: ming\_yann\_lim@ttsh.com.sg



# Acknowledgement

The Editorial Board of the *Annals*, Academy of Medicine, Singapore gratefully acknowledges the generous support of

## The Lee Foundation

### Call for Images

The *Annals* invites you to submit high-resolution images of current and historical importance in medicine, with a short caption of about 100 words. Due acknowledgement will be given to published images. Please send your photos to: [annals@ams.edu.sg](mailto:annals@ams.edu.sg).

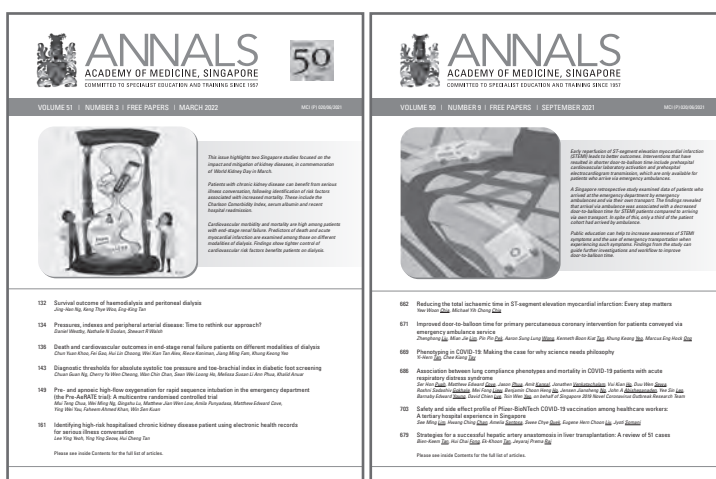

### Copyright

Copyright of all content is held by the *Annals*, Academy of Medicine, Singapore and protected by copyright laws governed by the Republic of Singapore. Personal use of material is permitted for research, scientific and/or information purposes only. No part of any material in this journal may be copied, distributed, reproduced, republished, or used without the permission of the *Annals*, Academy of Medicine, Singapore. The *Annals'* material may not be modified or used to create derivative works. Requests for permission to use copyrighted material must be sent to the Editor. The contents herein are not to be quoted in the press without permission of the Editor.

### Disclaimer

All published articles do not necessarily reflect the official policy of the Academy of Medicine, Singapore. The Academy cannot accept responsibility for the correctness or accuracy of the articles' contents, claims and opinions expressed. The appearance of advertisements in the *Annals* does not constitute an approval or endorsement by the Academy of the product or service advertised.



**ANNALS, ACADEMY OF MEDICINE, SINGAPORE**

81 Kim Keat Road, #11-00 & 12-00, NKF Centre, Singapore 328836

Tel: +65 6593 7800 | Fax: +65 6593 7867 | Email: [annals@ams.edu.sg](mailto:annals@ams.edu.sg) | Website: <https://www.annals.edu.sg>

Online submission: <https://aams.manuscriptmanager.net>



**ANNALS, ACADEMY OF MEDICINE, SINGAPORE**

81 Kim Keat Road, #11-00 & #12-00 NKF Centre, Singapore 328836

Tel: +65 6593 7800 | Fax: +65 6593 7867 | Email: [annals@ams.edu.sg](mailto:annals@ams.edu.sg) | Website: <https://www.annals.edu.sg>